

Print mark contrast sensor

DK20-9,5/110/124



- Diffuse mode sensor for recording any print mark
- Static TEACH-IN: automatic switching threshold adaptation
- Optical system exchangeable by 90°
- 30 µs response time, suitable for extremely rapid scanning processes
- 3 emitter colors: green, red and blue

Print mark contrast sensor, 9.5 mm detection range, RGB light, light/dark on, external Teach-in, push-pull output, M12 plug



Function

The contrast sensor series DK10, DK2X, DKE2X and DK3X have an extreme robust and IP67 tight industrial standard housing with eight M5 metal reinforced inserts for sensor mounting. The lenses are made of high grade glass. All sensors offer different light spot shapes and orientations and have powerful push-pull outputs (NPN/PNP/push-pull).

The DK10 sensor series offers laser and LED light sources, a manual sensitivity adjustment and high sensing ranges up to 800 mm.

The DK20/DK21/DKE2X standard contrast sensor series offers a very good contrast recognition and are available in extreme robust stainless-steel housings (DKE).

The DK31/DK34/DK35 sensor series is designed for cutting edge contrast recognition at highest sensitivity level.

The series DK20/DK34 offer a static Teach-In, the DK21/DKE21/DK31/DK35 series offer a dynamic Teach-In.

Dimensions

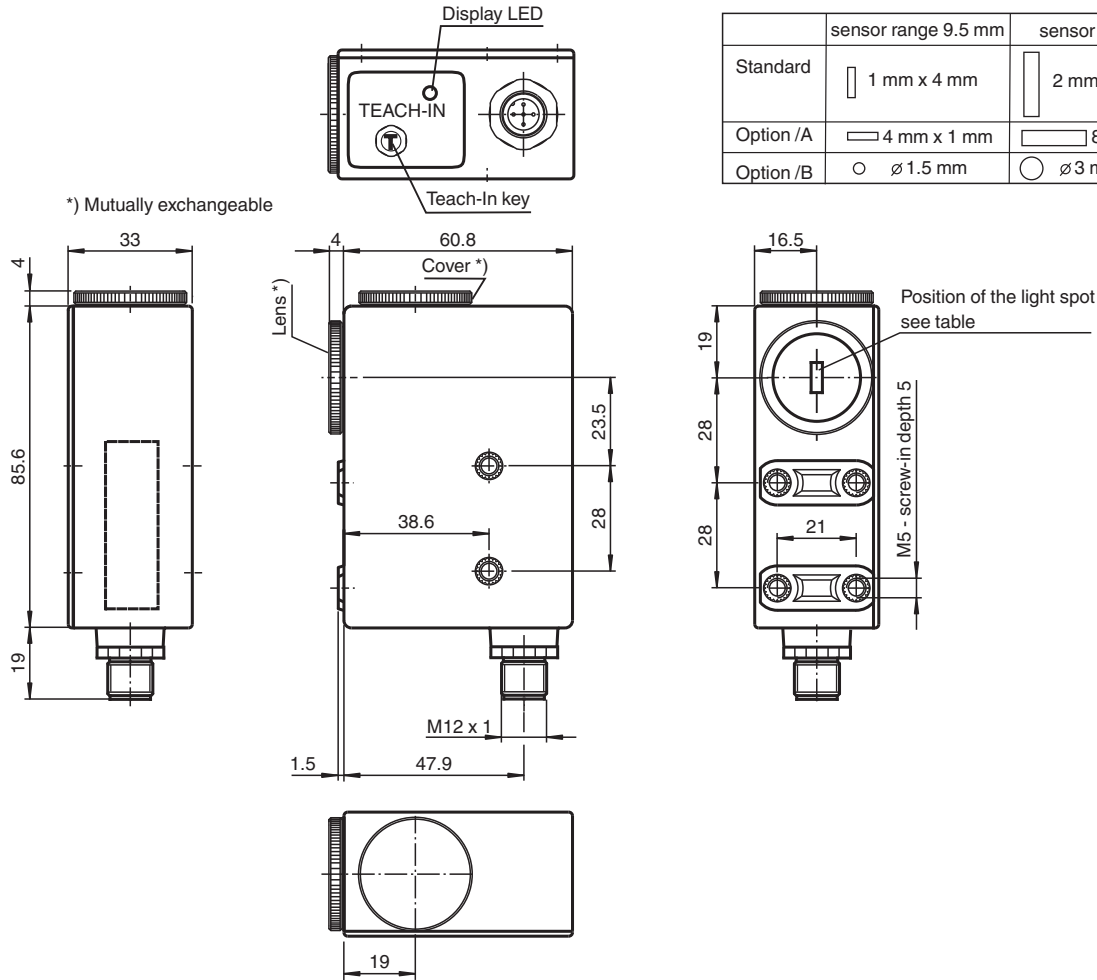

	sensor range 9.5 mm	sensor range 25 mm
Standard	1 mm x 4 mm	2 mm x 8.5 mm
Option /A	4 mm x 1 mm	8.5 mm x 2 mm
Option /B	∅ 1.5 mm	∅ 3 mm

Technical Data

General specifications	
Sensor range	9.5 mm ± 3 mm
Light source	LED
Light type	Visible green/red/blue, modulated light
Light spot representation	1 mm x 4 mm
Angle deviation	max. ± 3°
Ambient light limit	
Continuous light	7000 Lux
Teach-In	static Teach-In
Functional safety related parameters	
MTTF _d	650 a
Mission Time (T _M)	20 a
Diagnostic Coverage (DC)	0 %
Indicators/operating means	
Function indicator	LED yellow; switching operation: lights up if print mark is detected Teach-In operation: flashing slowly alarm display: flashing quickly, if no safe operation is possible
Control elements	Teach-In key
Electrical specifications	
Operating voltage	U _B 10 ... 30 V DC
Ripple	10 %
No-load supply current	I ₀ ≤ 70 mA
Input	

Release date: 2023-04-04 Date of issue: 2023-04-04 Filename: 418074_eng.pdf

Technical Data

Function input	Teach-In input	
Output		
Switching type	light/dark on switchable, results from the order of the Teach-In	
Signal output	Push-pull output, short-circuit protected, reverse polarity protected	
Switching voltage	PNP: $\geq (+U_B - 2.5 \text{ V})$, NPN: $\leq 1.5 \text{ V}$	
Switching current	max. 200 mA	
Switching frequency	f	16.5 kHz
Response time	30 μs	
Conformity		
Product standard	EN 60947-5-2	
Compliance with standards and directives		
Standard conformity		
Shock and impact resistance	IEC / EN 60068. half-sine, 40 g in each X, Y and Z directions	
Vibration resistance	IEC / EN 60068-2-6. Sinus. 10 -150 Hz, 5 g in each X, Y and Z directions	
Approvals and certificates		
UL approval	cULus Listed, Class 2 power source	
CCC approval	CCC approval / marking not required for products rated $\leq 36 \text{ V}$	
Ambient conditions		
Ambient temperature	-20 ... 60 °C (-4 ... 140 °F)	
Storage temperature	-20 ... 75 °C (-4 ... 167 °F)	
Mechanical specifications		
Housing width	33 mm	
Housing height	85.6 mm	
Housing depth	60.8 mm	
Degree of protection	IP67	
Connection	5-pin, M12 x 1 connector	
Material		
Housing	PC (glass-fiber-reinforced Makrolon)	
Optical face	glass	
Mass	200 g	

Connection Assignment

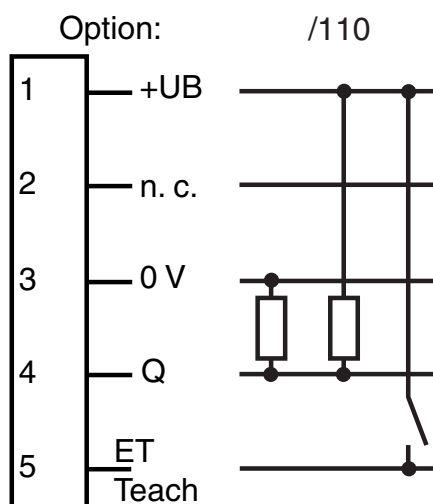

Connection Assignment

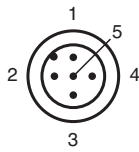



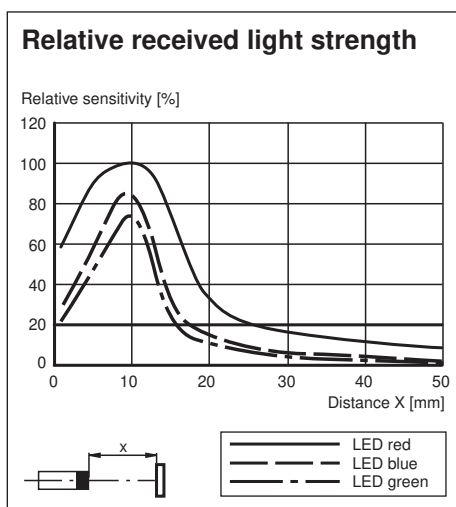

Wire colors in accordance with EN 60947-5-2

1	BN	(brown)
2	WH	(white)
3	BU	(blue)
4	BK	(black)
5	GY	(gray)



Accessories

	V15-G-5M-PVC	Female cordset single-ended M12 straight A-coded, 5-pin, PVC cable grey
	V15-W-5M-PVC	Female cordset single-ended M12 angled A-coded, 5-pin, PVC cable grey
	OMH-DK	Right-Angled Mounting Bracket
	OMH-DK-1	Flat Mounting Bracket

Release date: 2023-04-04 Date of issue: 2023-04-04 Filename: 418074_eng.pdf

Additional Information

Construction

This device is supplied with a changeable Lens. By interchanging Lens and cover the sensor is able to be modified from a side-looker to a top-looker and vice versa.

Adjustment

1. Point the light spot to the print mark. With mirroring or shiny object surface the sensor has to be tilt by 10° ... 15° .
2. Press Teach-In key at the device or apply a positive pulse (UB+) for at least 50 ms to the external Teach-In input. After finishing this first step, the indicator LED flashes slowly (approx. 1 Hz).
3. Point light spot to the underground/background.
4. Press Teach-In key or apply Teach-In signal once more.
5. If Teach-In successful: sensor in switching mod, LED off.
Alarme-Function: insufficient contrast. No reliable switching operation possible. Indicator LED flashes fast (approx. 4 Hz)
6. Return to switching mode when pressing key

The switching signal level is set automatically to the middle between print mark and background.

If there is the same contrast between mark and background for various transmitter colours, the sensor selects a transmitter colour by random.

For exact contrast evaluation the DK... , as an option, can be delivered with an additional analogue output.