

Print mark contrast sensor

DK21-25/110/124



- Diffuse mode sensor for recording any print mark
- Dynamic TEACH-IN: automatic switching threshold adaptation with one key pressure
- Optical system exchangeable by 90°
- 30 µs response time, suitable for extremely rapid scanning processes
- 3 emitter colors: green, red and blue

Print mark contrast sensor, 25 mm detection range, RGB light with rectangular light spot, external Teach-in, push-pull output, M12 plug



Function

The contrast sensor series DK10, DK2X, DKE2X and DK3X have an extreme robust and IP67 tight industrial standard housing with eight M5 metal reinforced inserts for sensor mounting. The lenses are made of high grade glass. All sensors offer different light spot shapes and orientations and have powerful push-pull outputs (NPN/PNP/push-pull).

The DK10 sensor series offers laser and LED light sources, a manual sensitivity adjustment and high sensing ranges up to 800 mm.

The DK20/DK21/DKE2X standard contrast sensor series offers a very good contrast recognition and are available in extreme robust stainless-steel housings (DKE).

The DK31/DK34/DK35 sensor series is designed for cutting edge contrast recognition at highest sensitivity level.

The series DK20/DK34 offer a static Teach-In, the DK21/DKE21/DK31/DK35 series offer a dynamic Teach-In.

Dimensions

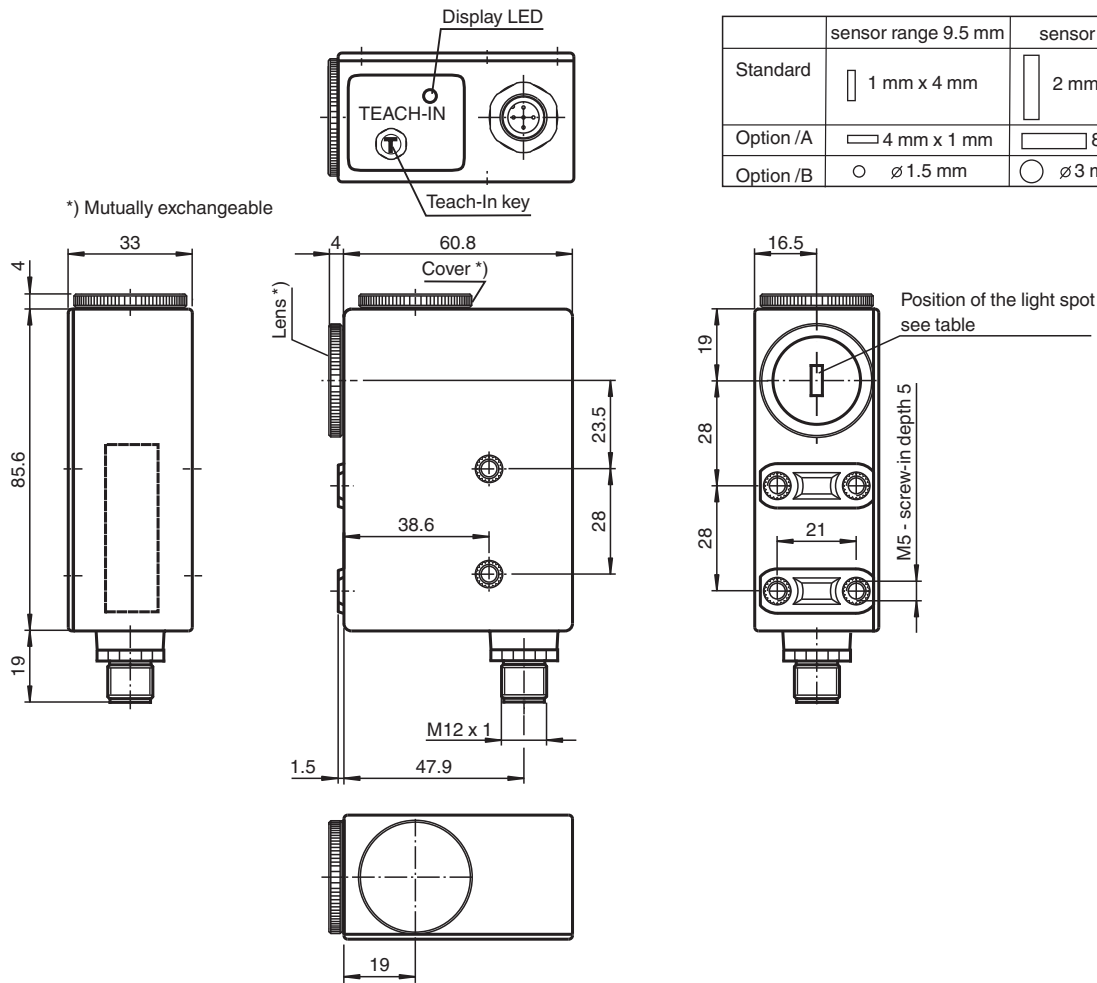

	sensor range 9.5 mm	sensor range 25 mm
Standard	1 mm x 4 mm	2 mm x 8.5 mm
Option /A	4 mm x 1 mm	8.5 mm x 2 mm
Option /B	∅ 1.5 mm	∅ 3 mm

Technical Data

General specifications	
Sensor range	25 mm ± 6 mm
Light source	LED
Light type	Visible green/red/blue, modulated light
Light spot representation	2 mm x 8.5 mm
Angle deviation	max. ± 3°
Ambient light limit	
Continuous light	7000 Lux
Teach-In	Dynamic Teach-In
Functional safety related parameters	
MTTF _d	650 a
Mission Time (T _M)	20 a
Diagnostic Coverage (DC)	0 %
Indicators/operating means	
Function indicator	LED yellow; switching operation: lights up if print mark is detected Alarm display: flashing quickly, if no safe operation is possible
Control elements	Teach-In key
Electrical specifications	
Operating voltage	U _B 10 ... 30 V DC
Ripple	10 %
No-load supply current	I ₀ ≤ 60 mA
Input	

Release date: 2023-04-04 Date of issue: 2023-04-04 Filename: 418094_eng.pdf

Technical Data

Function input	Teach-In input	
Output		
Signal output	Push-pull output, short-circuit protected, reverse polarity protected	
Switching voltage		PNP: $\geq (+U_B - 2.5 \text{ V})$, NPN: $\leq 1.5 \text{ V}$
Switching current		max. 200 mA
Switching frequency	f	16.5 kHz
Response time		30 μs
Conformity		
Product standard	EN 60947-5-2	
Compliance with standards and directives		
Standard conformity		
Shock and impact resistance		IEC / EN 60068. half-sine, 40 g in each X, Y and Z directions
Vibration resistance		IEC / EN 60068-2-6. Sinus. 10 -150 Hz, 5 g in each X, Y and Z directions
Approvals and certificates		
CCC approval	CCC approval / marking not required for products rated $\leq 36 \text{ V}$	
Ambient conditions		
Ambient temperature		-20 ... 60 °C (-4 ... 140 °F)
Storage temperature		-20 ... 75 °C (-4 ... 167 °F)
Mechanical specifications		
Housing width		33 mm
Housing height		85.6 mm
Housing depth		60.8 mm
Degree of protection		IP67
Connection		5-pin, M12 x 1 connector
Material		
Housing		PC (glass-fiber-reinforced Makrolon)
Optical face		glass
Mass		200 g

Connection Assignment

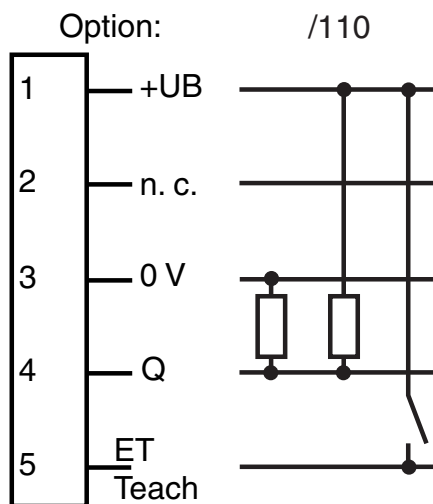

Connection Assignment

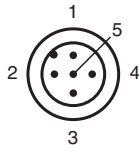



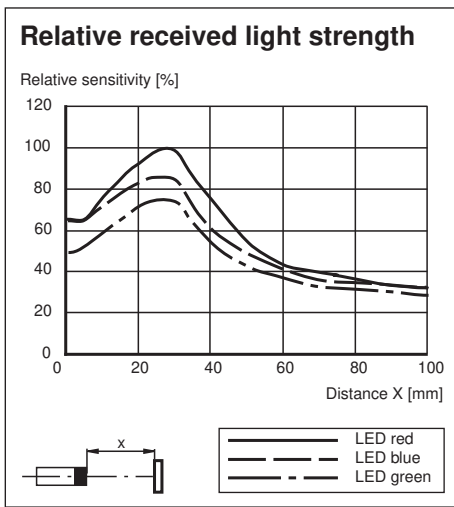

Wire colors in accordance with EN 60947-5-2

1	BN	(brown)
2	WH	(white)
3	BU	(blue)
4	BK	(black)
5	GY	(gray)



Accessories

	V15-G-5M-PVC	Female cordset single-ended M12 straight A-coded, 5-pin, PVC cable grey
	V15-W-5M-PVC	Female cordset single-ended M12 angled A-coded, 5-pin, PVC cable grey
	OMH-DK	Right-Angled Mounting Bracket
	OMH-DK-1	Flat Mounting Bracket

Release date: 2023-04-04 Date of issue: 2023-04-04 Filename: 418094_eng.pdf

Teach-In

Adjustment

1. Adjust light spot to background. The sensor must be bend 10° to 15° towards the material surface if the object surface is reflective or glossy.
2. Keep Teach-In key at the device pressed or connect +UB to external input ET continuously. The Teach-In process starts 50 ms after the Teach-In signal is connected.
3. The print mark must cover the light spot for at least 1 ms completely. Move the print mark through the light spot.
4. The Teach-In process finishes 50 ms after the Teach-In-signal (keystroke or ET) with the following possible conditions:

Teach-In successful: the non-volatile saving of the taught-in values in EEPROM follows. Indicator-LED illuminates when print mark is detected. Push-pull output switches when print mark is detected to $+U_B$, with background to 0 V.

ALARM-function: Recorded contrast for all emitter light colours too faint. Indicator-LED flashes with approx. 4 Hz, optional analog-output shows minimal signal. Return to the operation mode with the latest accepted values after keystroke or $+U_B$ at ET (at least 50 ms).

The switching level is centered between the evaluated print mark/background-contrast values.

The sensor automatically selects and stores the most suitable emitter colour for the best print mark/background-contrast.

For exact contrast evaluation, the DK... can optionally be equipped with an additional analogue output.

Emitter-test function:

1. Switch on sensor supply while active Teach-In signal (keystroke or ET).
2. After Teach-In is released, the green emitter is switched.
3. The red emitter is switched after the second Teach-In.
4. The blue emitter is switched after the third Teach-In.
5. After the fourth Teach-In: normal switching operation.

The switching of the output is suppressed during the test operation.

