

Area scanner

FLT-8-H-2800-300/120a



- Area scanner with long detection range for detecting people and objects
- Version with Background suppression
- Ignores objects outside of selected area
- Version with detection area 300 mm x 500 mm

Area scanner with large detection range for detecting people and objects



Function

The FLT-8 series active infra-red area scanners detect people and objects located within a defined sensing field, regardless of background and whether or not they are moving. The sensors generate a clearly defined spatial sensing field, which can be mechanically adjusted. This sensing field is comprised of three or four individual light beams.

Dimensions

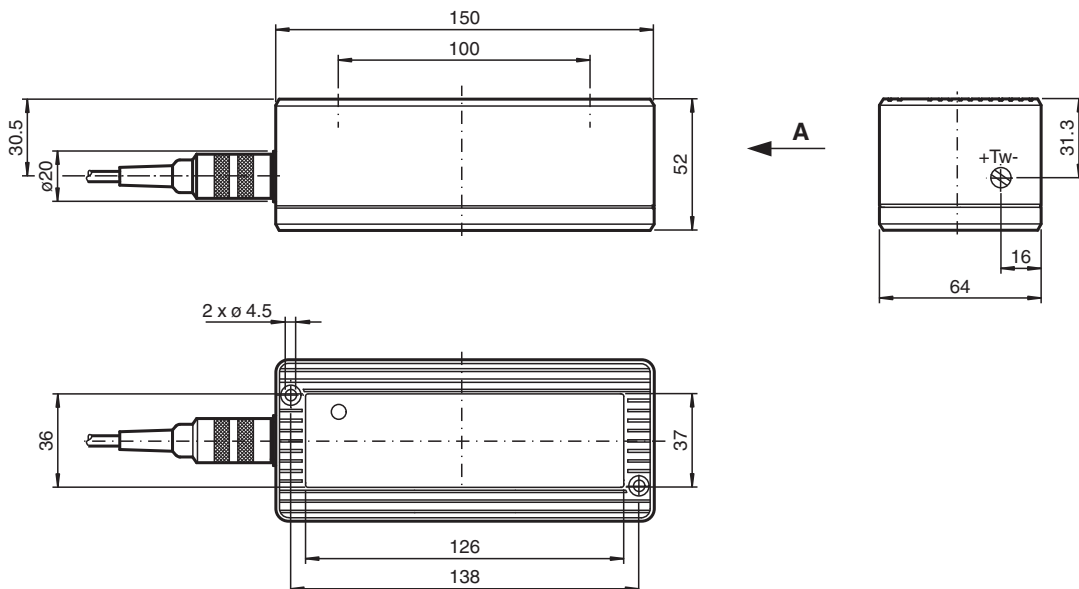

Technical Data

General specifications		
Detection field		300 mm x 500 mm at 2000 mm sensor range
Detection range min.		100 ... 1200 mm
Detection range max.		100 ... 2800 mm
Light source		4 x IRED
Light type		modulated infrared light
Light spot representation		43 mm x 43 mm at 2000 mm
Marking		CE
Operating mode		Background suppression
Functional safety related parameters		
MTTF _d		470 a
Mission Time (T _M)		20 a
Diagnostic Coverage (DC)		0 %
Indicators/operating means		
Function indicator		LED red
Control elements		Sensing range adjuster
Electrical specifications		
Operating voltage	U _B	15 ... 48 V DC
No-load supply current	I ₀	100 mA
Power consumption	P ₀	2.5 W
Output		
Switching type		light/dark on
Signal output		2 PNP, complementary, short-circuit protected, open collectors
Switching voltage		48 V DC
Switching current		200 mA
Response time		100 ms
De-energized delay	t _{off}	200 ms
Compliance with standards and directives		
Standard conformity		
Product standard		IEC 60947-5-2
Emitted interference		EN 61000-6-3
Standards		EN 61000-6-2 without EN 61000-4-5, EN 61000-4-11
Ambient conditions		
Ambient temperature		-20 ... 60 °C (-4 ... 140 °F)
Storage temperature		-20 ... 75 °C (-4 ... 167 °F)
Mechanical specifications		
Mounting height		max. 2800 mm
Degree of protection		IP65
Connection		Connector, Binder series 581, 5-pin
Material		
Housing		Makrolon GV30 black
Optical face		Glass, red
Mass		320 g
General information		
Scope of delivery		2 m Connecting cable

Connection Assignment

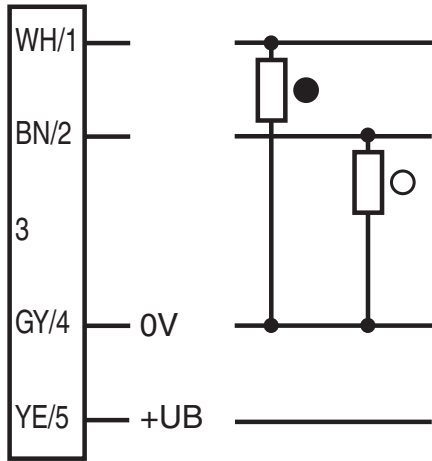

○ = Light on
● = Dark on

Assembly

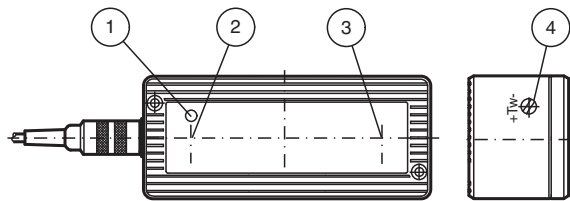

1	Functional display	red
2	Emitter	
3	Receiver	
4	Detection range adjuster	

Characteristic Curve

Size of detection field
FLT...300

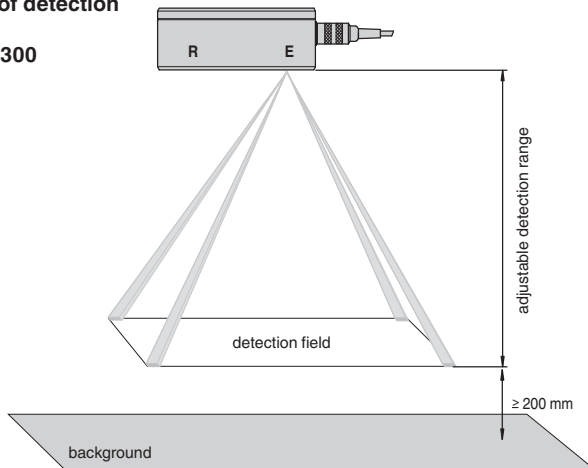

Detection field size versus adjusted detection range:

detect. range	detection field size	spot size
1500 mm	380 mm x 220 mm	30 mm x 30 mm
1800 mm	450 mm x 270 mm	35 mm x 35 mm
2000 mm	500 mm x 300 mm	43 mm x 43 mm
2500 mm	610 mm x 370 mm	57 mm x 57 mm
2800 mm	685 mm x 415 mm	64 mm x 64 mm

Release date: 2023-04-04 Date of issue: 2023-04-04 Filename: 419522_eng.pdf

Application

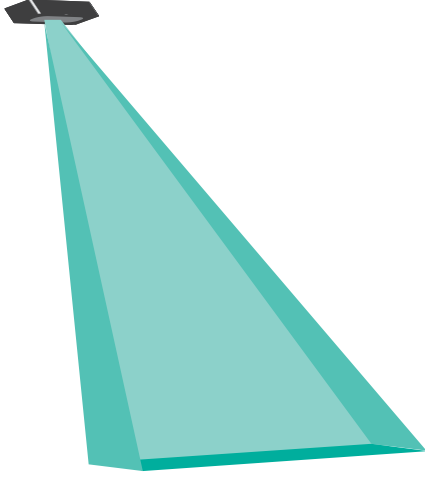

Accessories

	Montageplatte FLT	Mounting plate for FLT-8 series sensors
---	--------------------------	---

Function Principle

The FLT-8-H serves to detect persons and objects as they enter the detection range of the device. The device responds at the moment the object to be detected is hit by at least one of the light beams. The sensor functions as a sensing device with background suppression.

In case the background (floor, wall) produces permanent or temporary sparkling reflections, e. g. due to wetness, the sensor needs to be turned by at least 5° around its longitudinal axis during installation to prevent mirror effects (fig).

Several sensors can be arranged in such a way that their scanned areas can border on each other directly or overlap without any switching error occurring.

The light scanner function is displayed by a red LED which can be observed through the front disc.

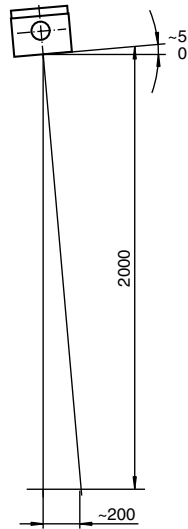

Application

- Protection mechanism for closing edges on automatic doors and gates
- Monitoring hazardous areas, such as crushing or shearing edges
- Anti-collision protection on automated guided vehicles
- Presence checks for people