

Background suppression sensor

RL28-8-H-700-IR/47/105

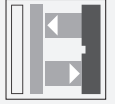

- Ultra bright LEDs for power on and switching state
- Minimal black-white difference through the infrared transmission LED
- Not sensitive to ambient light, even with switched energy saving lamps
- Waterproof, degree of protection IP67
- Protection class II

Background suppression sensor



Dimensions

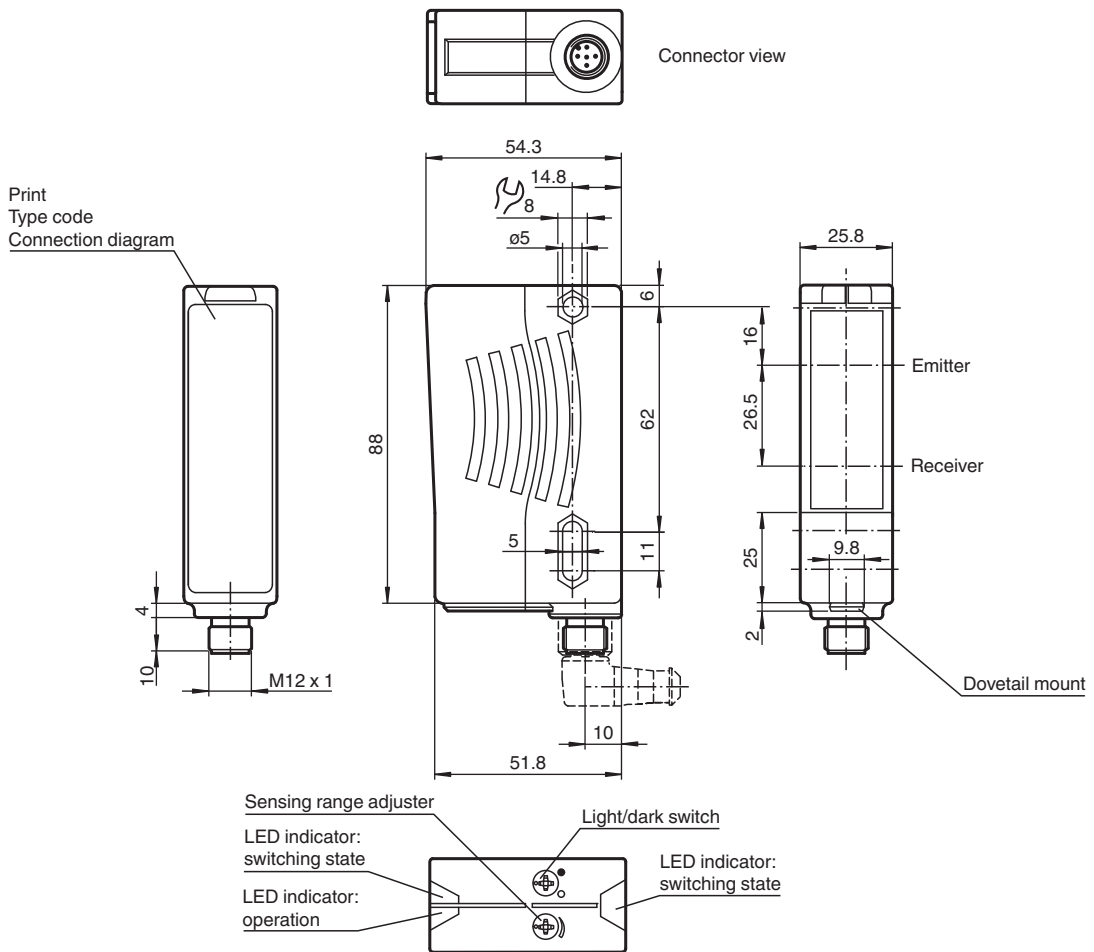

Release date: 2023-04-04 Date of issue: 2023-04-04 Filename: 419614_eng.pdf

Technical Data

General specifications		
Detection range		20 ... 700 mm
Detection range min.		20 ... 200 mm
Detection range max.		20 ... 700 mm
Background suppression		max. + 10 % of the upper limit of the detection range
Light source		IRED
Light type		modulated infrared light , 880 nm
Black-white difference (6 %/90 %)		< 8 %
Diameter of the light spot		approx. 24 mm at a distance of 700 mm
Opening angle		transmitter 2° receiver 2°
Ambient light limit		50000 Lux
Functional safety related parameters		
MTTF _d		720 a
Mission Time (T _M)		20 a
Diagnostic Coverage (DC)		0 %
Indicators/operating means		
Operation indicator		LED green
Function indicator		2 LEDs yellow ON: object inside the scanning range OFF: object outside the scanning range
Control elements		Sensing range adjuster , Light-on/dark-on changeover switch
Electrical specifications		
Operating voltage	U _B	10 ... 30 V DC
Ripple		10 %
No-load supply current	I ₀	≤ 40 mA
Output		
Switching type		light/dark on switchable
Signal output		2 PNP, complementary, short-circuit protected, reverse polarity protected , open collectors
Switching voltage		max. 30 V DC
Switching current		max. 200 mA
Switching frequency	f	250 Hz
Response time		2 ms
Conformity		
Product standard		EN 60947-5-2
Approvals and certificates		
Protection class		II, rated voltage ≤ 250 V AC with pollution degree 1-2 according to IEC 60664-1
UL approval		E87056 , cULus Listed , class 2 power supply , type rating 1
Ambient conditions		
Ambient temperature		-40 ... 60 °C (-40 ... 140 °F)
Storage temperature		-40 ... 60 °C (-40 ... 140 °F)
Mechanical specifications		
Housing width		25.8 mm
Housing height		88 mm
Housing depth		54.3 mm
Degree of protection		IP67
Connection		5-pin, M12 x 1 connector
Material		
Housing		Plastic ABS
Optical face		plastic
Connector		plastic
Mass		70 g

Connection Assignment

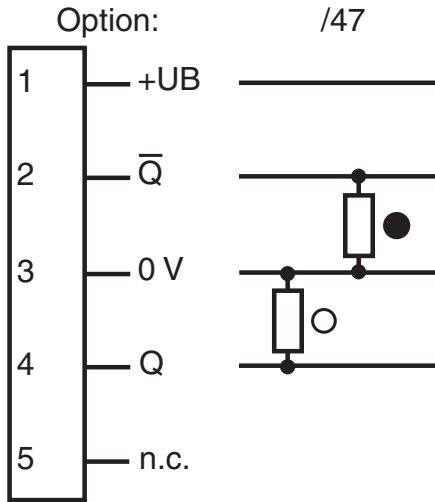

○ = Light on
● = Dark on

Connection Assignment

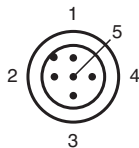

Wire colors in accordance with EN 60947-5-2

1	BN	(brown)
2	WH	(white)
3	BU	(blue)
4	BK	(black)
5	GY	(gray)

Characteristic Curve

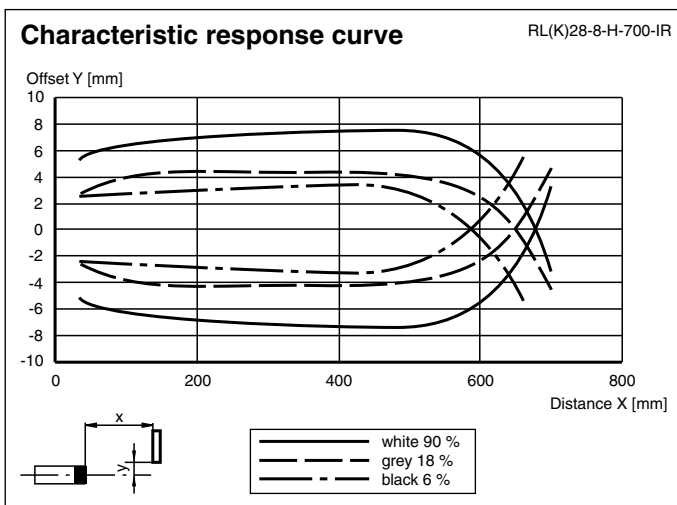

Release date: 2023-04-04 Date of issue: 2023-04-04 Filename: 419614_eng.pdf



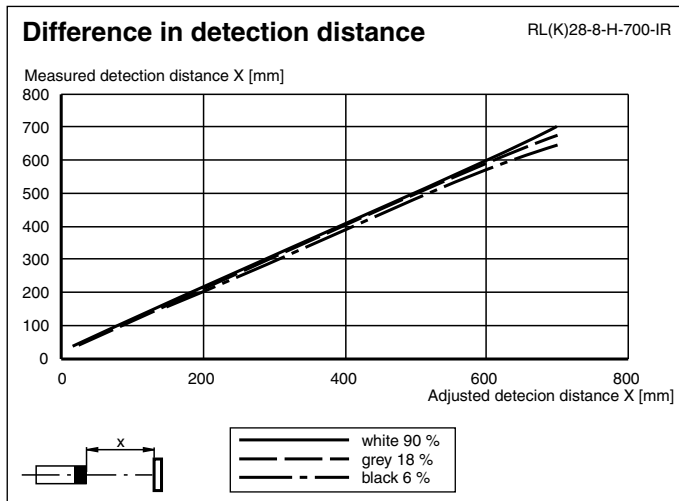

Characteristic Curve



Application



Accessories

	OMH-05	Mounting aid for round steel \varnothing 12 mm or sheet 1.5 mm ... 3 mm
	OMH-21	Mounting bracket: mounting aid for sensors in the RL* series
	OMH-22	Mounting aid for RL* series
	OMH-RLK29-HW	Mounting bracket for rear wall mounting
	OMH-RL28-C	Weld slag cover model

Additional Information

Mounting instructions:

There are two bore holes for mounting the sensor with M5 bolts. The base surface must be flat to avoid distorting the housing during mounting. It is advisable to secure the bolts with spring washers so that the sensor does not become misaligned.

Outdoor installation:

The sensor must be protected against rain and splash-water, possibly must a cover be installed.

Adjustment:

Adjust the sensor on the background. After the connecting to the power supply the green LED illuminates. In case the yellow LEDs illuminate too, the detection range needs to be reduced with the detection range adjuster, until the yellow LEDs is switched off. If the object is moved into the detection range the yellow LEDs illuminates.

Driving inductive loads:

If the sensor are used to drive inductive loads, the following safety procedures must be carried out:

For operating voltage of 10 V DC ... 30 V DC: fit a protection diode, max. 200 mA