

Cable socket, shielded

V19-W-BK5M-PUR-U/ABG

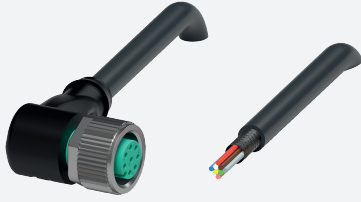

- Degree of protection IP68 / IP69
- Free of paint wetting interfering substances
- Resistant to microbes and hydrolysis
- UV resistant
- UL listed for USA and Canada
- Halogen-free
- Shield connected to screw connection
- Specific design protects against loosening and inaccurate installation

Female cordset single-ended M12 angled A-coded, 8-pin, PUR cable black, shielded, UL approved, drag chain suitable



Dimensions

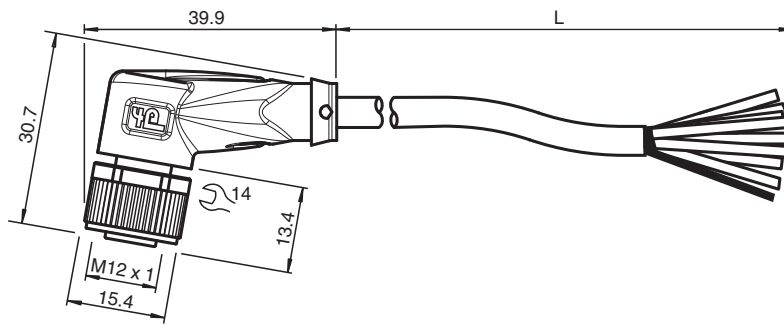

Technical Data

General specifications

| | |
|-------------------|------------------|
| Connector 1 | |
| Connection | socket |
| Construction type | M12 |
| Style | angled |
| Locking | screw connection |
| Number of pins | 8 |
| Coding | A-coded |
| Connector 2 | |
| Connection | cable end |

Electrical specifications

| | | |
|-------------------|-------|-----------------|
| Operating voltage | U_B | max. 30 V AC/DC |
| Operating current | I_B | max. 2 A |

Conformity

| | |
|-----------------------|-------------------------------------|
| Degree of protection | EN 60529 |
| Plug connection | connector M12 x 1 : IEC 61076-2-101 |
| Flammability | UL 1581; DIN EN 60332-2-2 |
| Halogen-free | IEC 60754-1 |
| Microbial resistance | EN 50363 |
| Hydrolysis resistance | EN 50363 |

Approvals and certificates

Release date: 2023-09-04 Date of issue: 2023-09-05 Filename: 456513_eng.pdf

Technical Data

| | | |
|----------------------------------|--|-----|
| UL approval | AWM STYLE 20549 I/II A/B 80°C 300V FT2 (cable) | |
| UL File Number | E231213 | |
| Ambient conditions | | |
| Ambient temperature | | |
| Plug connector | -40 ... 90 °C (-40 ... 194 °F) | |
| Cable, fixed | -40 ... 80 °C (-40 ... 176 °F) | |
| Cable, flexing | -20 ... 80 °C (-4 ... 176 °F) | |
| Pollution degree | 3 | |
| Mechanical specifications | | |
| Plug connector | | |
| Tightening torque | 0.6 Nm | |
| Loosening protection | available | |
| Tool installation | straight knurling and hexagon nut SW = 14 mm | |
| Mating cycles | min. 100 | |
| Shielding | shield connected to screw connection | |
| Degree of protection | IP68 / IP69 | |
| Cable | according to IEC/EN 60228 (DIN VDE 0295) class 6 | |
| Sheath diameter | 6 mm | |
| Bending radius | > 10 x cable diameter, moving > 5 x cable diameter, fixed | |
| Sheath stripping force | max. 80 N / 300 mm | |
| Sheath color | black (similar to RAL 9005) | |
| Number of cores | 8 | |
| Core cross section | 0.25 mm ² | |
| Cores color | Core 1: white Core 2: brown Core 3: green Core 4: yellow Core 5: grey Core 6: pink Core 7: blue Core 8: red | |
| Core construction | 32 x 0.1 mm Ø | |
| Shield | tinned copper braiding, 85 % coverage | |
| Length | L | 5 m |
| Cable code | Li 9Y C 11Y 8 x 0,25 | |
| Drag chain suitability | | |
| Drag chain cycles | min. 5000000 | |
| Motion velocity | max. 3 m/s | |
| Traverse distance | max. 5 m | |
| Acceleration | max. 5 m/s ² | |
| Material | | |
| PWIS free | yes | |
| Halogen-free | yes | |
| Plug connector | | |
| Screw connection | Zinc diecast, nickel-plated | |
| Body | TPU, black | |
| Seal | FKM | |
| Contact surface | gold plated (Au) | |
| Flammability | V-2 | |
| Cable | | |
| Sheathing | PUR based on polyether | |
| Core insulation | PP | |
| UV resistance | yes | |
| Chemical resistance | good | |
| Oil resistance | yes | |





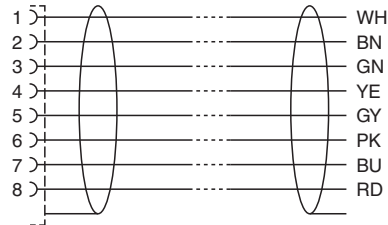
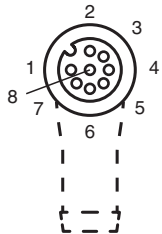

Technical Data

| | |
|------------------------------|-----|
| Cooling lubricant resistance | yes |
| Microbial resistance | yes |
| Hydrolysis resistance | yes |
| Flammability | FT2 |

Connection



Accessories

| | | |
|---|------------------------------|--|
|  | MH V1-SCREWDRIVER | Torque screwdriver (0.6 Nm) |
|  | MH V1-BIT M12 | plug-in cap M12 |
|  | V1/V3-LABELHOLDER | Label holder |
|  | V1/V3-LABEL | Label plate |
|  | MH V1-Holder | Modular universal holder for M12 connectors |
|  | V1-CLIP | Unlocking protector for M12 connector |
|  | V1-MARKING-RING-COLOR | Marking rings for M12 connectors, various colors |