

Female cordset

V3-WM-YE5M-PVC-U

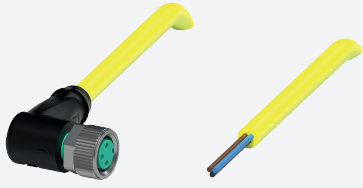

- Degree of protection IP68
- UL listed for USA and Canada
- Specific design protects against loosening and inaccurate installation

Female cordset single-ended M8 angled A-coded, 3-pin, PVC cable yellow, UL approved



Dimensions

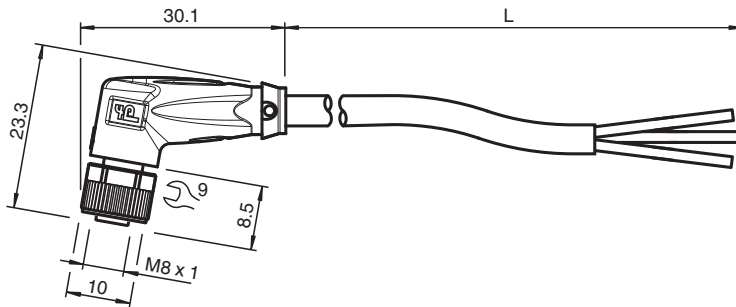

Technical Data

General specifications

Connector 1	
Connection	socket
Construction type	M8
Style	angled
Locking	screw connection
Number of pins	3
Coding	A-coded
Connector 2	
Connection	cable end

Electrical specifications

Operating voltage	U_B	max. 48 V AC / 60 V DC
Operating current	I_B	max. 3 A

Conformity

Degree of protection	EN 60529
Plug connection	connector M8 x 1 : IEC 61076-2-104
Flammability	UL 1581 , IEC 60332-1-2

Approvals and certificates

UL approval	AWM STYLE 2095 AWM I/II A/B 80°C 300V FT1 (cable)
UL File Number	E231213

Ambient conditions

Ambient temperature	
---------------------	--

Release date: 2023-09-04 Date of issue: 2023-09-04 Filename: 456516_eng.pdf

Technical Data



Plug connector		-40 ... 90 °C (-40 ... 194 °F)
Cable, fixed		-25 ... 80 °C (-13 ... 176 °F)
Cable, flexing		-5 ... 80 °C (23 ... 176 °F)
Pollution degree		3
Mechanical specifications		
Plug connector		
Tightening torque		0.4 Nm
Loosening protection		available
Tool installation		straight knurling and hexagon nut SW = 9 mm
Mating cycles		min. 100
Degree of protection		IP68
Cable		
Sheath diameter		4.3 mm
Bending radius		> 15 x cable diameter, moving > 5 x cable diameter, fixed
Sheath stripping force		max. 50 N / 300 mm
Sheath color		yellow (similar to RAL 1021)
Number of cores		3
Core cross section		0.34 mm ²
Cores color		Core 1: brown Core 3: blue Core 4: black
Core construction		19 x 0.15 mm Ø
Length	L	5 m
Cable code		Li YY 3 x 0,34
Material		
Plug connector		
Screw connection		Zinc diecast, nickel-plated
Body		TPU, black
Seal		FKM
Contact surface		gold plated (Au)
Flammability		V-2
Cable		
Sheathing		PVC
Core insulation		PVC
Flammability		FT1

Connection





1)	BN
3)	BU
4)	BK

Accessories

	MH V3-SCREWDRIVER	Torque screwdriver (0.4 Nm)
	MH V3-BIT M8	plug-in cap for M8

Accessories

	V1/V3-LABELHOLDER	Label holder
	V1/V3-LABEL	Label plate
	MH V3-Holder	Modular universal holder for M8 connectors