

# Cable Glands, Metal, Barrier Glands for armored Cables

## CG.BA.M20S.SS.S.16.K01



- For armored cables
- Barrier gland
- Stainless Steel
- Thread M20
- Seal silicone
- Ex db, Ex eb and Ex tb certified
- Suitable for operation in Zone 1, Zone 2, Zone 21 and Zone 22
- Packaging unit: 1 piece, kit with accessories
- USA usage prohibited!



### Dimensions

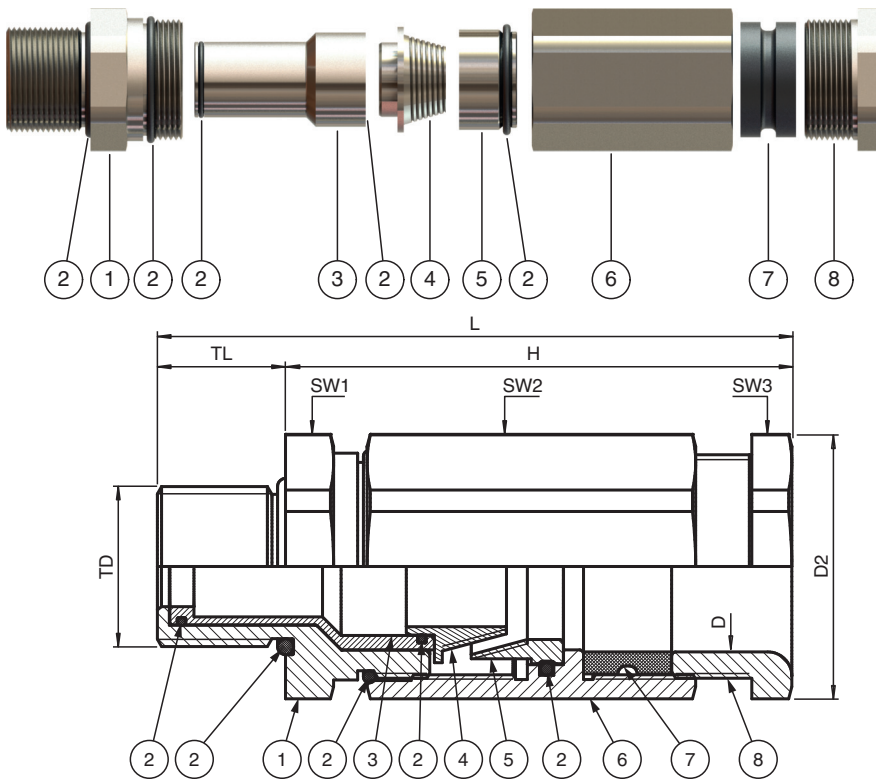

Release date: 2025-05-19 Date of issue: 2025-05-19 Filename: 70100182\_eng.pdf

## Dimensions

Details see data table

Legend	
1	Gland body basis
2	O-Ring
3	Barrier tube
4	Armor cone (CG.BA.*)
5	Swifel braid ring (CG.BA.*)
6	Gland body
7	Seal insert
8	Pressure nut
9	Barrier pressure ring bushing (CG.BN.*)
D	Clamping range, cable sheath diameter
D2	Width across corners
H	Length outside enclosure
L	Total length
SW*	Width across flats
TD	Thread size
TL	Thread length
	Barrier details in data table
CQ	Max. number of cores
DS	Core cross-section, single-core cable
DM	Total core cross-section, multi-core cable
CC	Max. total core cross-section area

## Technical Data

### Mechanical specifications

Cable type	armored cables
Clamping range (D)	6 ... 13 mm
Thread type	metric ISO pitch 1.5 mm
Thread size (TD)	M20
Degree of protection	IP66 / IP68
Material	
Finish	inherent color silver
Cable gland	stainless steel
O-Ring	silicone
Seal insert	silicone
Casting compound	
Description	EP 2122 Epoxy Putty Compound must be ordered separately
Part number	70101827
Mass	60 g
Required amount per cable gland	7 g
Packaging units per delivery quantity cable glands	1
Cable glands per packaging unit casting compound	8
Mass	
Individual component	approx. 190 g

Release date: 2025-05-19 Date of issue: 2025-05-19 Filename: 70100182\_eng.pdf

## Technical Data

Packing unit	approx. 197 g
<b>Dimensions</b>	
Width across corners (D2)	27 mm
Min. armor thickness	0.8 mm
Max. armor thickness	1.25 mm
Min. braiding thickness	0.3 mm
Max. braiding thickness	0.8 mm
Diameter thru-hole (DT)	20 ... 20.2 mm
Number of cores (CQ)	max. 9
Core cross section, single-core cable (DS)	1.5 ... 9.5 mm
Total core cross section, multi-core cables (DM)	1.5 ... 9.5 mm
Total core cross section area (CC)	max. 70.9 mm <sup>2</sup>
Length outside enclosure (H)	61.5 mm
Width across flats (SW1)	25 mm
Width across flats (SW2)	25 mm
Width across flats (SW3)	25 mm
Thread length (TL)	16 mm
Total length (L)	77.5 mm
<b>Tightening torque</b>	
Nut torque at enclosure (SW1)	60 Nm
Nut torque 2 (SW2)	60 Nm
Nut torque 3 (SW3)	30 Nm
<b>Ambient conditions</b>	
Ambient temperature	-60 ... 100 °C (-76 ... 212 °F)
<b>Data for application in connection with hazardous areas</b>	
EU-type examination certificate	CESI 18 ATEX 037X
Marking	Ⓜ II 2 GD Ex db IIC Gb Ex eb IIC Gb Ex tb IIIC Db
<b>International approvals</b>	
IECEx approval	IECEx CES 18.0030X
UKCA approval	CML 22 UKEX 1268X
CCC approval	2021312313000454
<b>Conformity</b>	
Degree of protection	EN 60529
CE marking	0102
<b>General information</b>	
Delivery quantity	1
Scope of delivery	Cable gland pair of gloves Brief instructions
Supplementary information	EC-Type Examination Certificate, Statement of Conformity, Declaration of Conformity, Attestation of Conformity and instructions have to be observed where applicable. For information see <a href="http://www.pepperl-fuchs.com">www.pepperl-fuchs.com</a> .

Release date: 2025-05-19 Date of issue: 2025-05-19 Filename: 70100182\_eng.pdf