

Connection cable, Ethernet V1SD-W-70M-PUR-ABG-V45-G

- Hard-wearing PUR cable
- Industrial Ethernet
- D coding for Ethernet
- CAT5/CAT5e cable
- Free of paint wetting interfering substances
- Halogen-free
- Screw connection suitable for tool assembly
- Immunity to vibration, with mechanical latching

Ethernet bus cable M12 plug angled D-coded to RJ45 Ethernet-coded, 4-pin, PUR cable blue, Cat5e, shielded



Dimensions

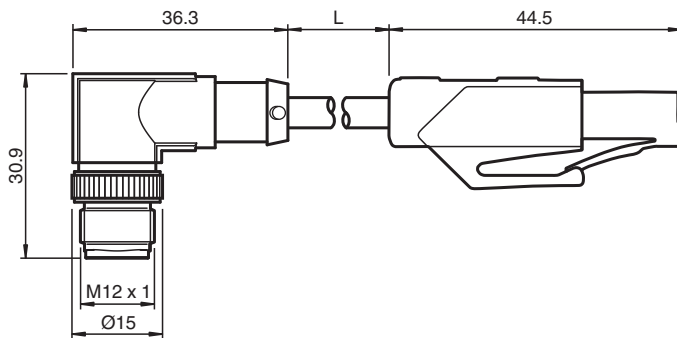

Technical Data

General specifications

Connector 1			
Connection		plug	
Construction type		M12	
Style		angled	
Locking		screw connection	
Number of pins		4	
Coding		D-coded	
Connector 2			
Connection		plug	
Construction type		RJ45	
Style		straight	
Locking		snap locking	
Number of pins		8	
Electrical specifications			
Operating voltage	U_B	max. 48 V AC / 60 V DC	
Operating current	I_B	max. 1 A	
Conformity			
Degree of protection		EN 60529	

Release date: 2023-07-12 Date of issue: 2023-07-13 Filename: 70101608_eng.pdf

Technical Data

Plug connection	connector M12 x 1 : IEC 61076-2-101 connector RJ45 : IEC 60603-7
Component category	CAT5 (IEC 11801) , CAT5e (IEC 61156-6)
Flammability	IEC 60332-1-2 / UL 2556
Halogen-free	IEC 60754-1
Ambient conditions	
Ambient temperature	
Connector 1	-25 ... 90 °C (-13 ... 194 °F)
Connector 2	-25 ... 60 °C (-13 ... 140 °F)
Cable, fixed	-40 ... 80 °C (-40 ... 176 °F)
Cable, flexing	-20 ... 80 °C (-4 ... 176 °F)
Mechanical specifications	
Connector 1	
Tightening torque	0.4 Nm
Loosening protection	available
Tool installation	straight knurling
Mating cycles	min. 100
Shielding	shield connected to screw connection
Degree of protection	IP65/IP67
Connector 2	
Loosening protection	available
Mating cycles	min. 750
Shielding	shield connected to connector
Degree of protection	IP20
Cable	
Sheath diameter	6.4 mm
Bending radius	> 8 x cable diameter, moving > 4 x cable diameter, fixed
Sheath color	water blue (RAL 5021)
Number of cores	4
Core cross section	0.14 mm ²
Cores color	Core 1-1: white/orange Core 2-3: white/green Core 3-2: orange Core 4-6: green
Core construction	7 x 0.16 mm Ø twisted pairs
Shield	aluminum-lined polyester foil Tinned copper braiding, 70 % coverage
Length	L 70 m
Material	
PWIS free	yes
Halogen-free	yes
Connector 1	
Screw connection	Zinc diecast, nickel-plated
Body	TPU, black
Contact surface	Ni/Au
Flammability	V-2
Connector 2	
Body	PA, grey
Contact surface	Ni/Au
Flammability	V-0
Cable	
Sheathing	PUR
Core insulation	PE
Flammability	VW-1

Release date: 2023-07-12 Date of issue: 2023-07-13 Filename: 70101608_eng.pdf

Connection

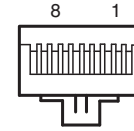
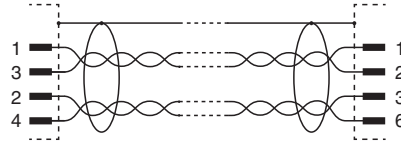
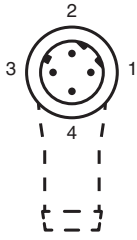

Accessories

	MH V1-SCREWDRIVER	Torque screwdriver (0.6 Nm)
	MH V1-BIT M12	plug-in cap M12
	V1/V3-LABELHOLDER	Label holder
	V1/V3-LABEL	Label plate
	MH V1-Holder	Modular universal holder for M12 connectors
	V1-CLIP	Unlocking protector for M12 connector
	V1-MARKING-RING-COLOR	Marking rings for M12 connectors, various colors