

Resistance Repeater

KCD2-RR2-Ex1.SP

- 1-channel isolated barrier
- 24 V DC supply (Power Rail)
- Resistance and RTD input (Pt100, Pt500, Pt1000)
- Resistance output
- Accuracy 0.1 %
- Line fault detection (LFD) for Pt100
- Housing width 12.5 mm
- Connection via spring terminals with push-in connection technology
- Up to SIL 2 acc. to IEC/EN 61508



SIL 2



Function

This isolated barrier is used for intrinsic safety applications. It transfers resistance values of RTDs or potentiometers from hazardous areas to safe areas. A 2-, 3-, or 4-wire technique is available depending on the required accuracy. The input card of the control system measures the same load as if it were connected directly to the resistance in a hazardous area.

Connection

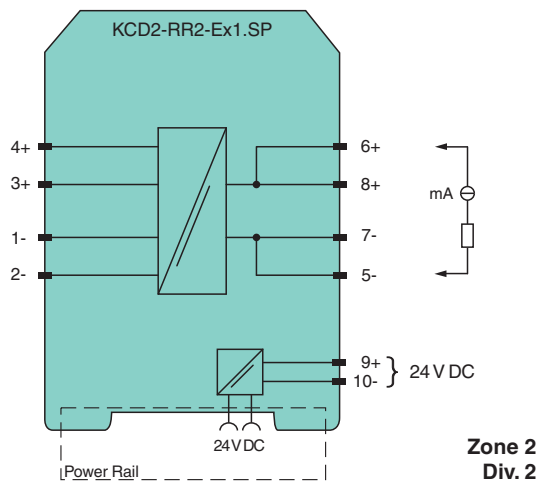
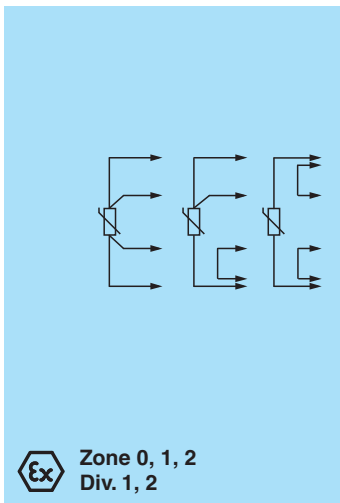

Technical Data

General specifications	
Signal type	Analog input
Functional safety related parameters	
Safety Integrity Level (SIL)	SIL 2
Supply	
Connection	Power Rail or terminals 9+, 10-
Rated voltage	U_r 19 ... 30 V DC
Ripple	within the supply tolerance
Rated current	I_r < 28 mA
Power consumption	0.35 W (24 V and 1 mA sense current), 0.85 W (30 V and 10 mA sense current)
Input	

Release date: 2021-12-13 Date of issue: 2021-12-13 Filename: 70103018_eng.pdf

Technical Data

Connection side	field side
Connection	terminals 1, 2, 3, 4
Line fault detection	yes, at Pt100
Lead resistance	≤ 10 % of resistance value
Transmission range	0 ... 10 mA
Available voltage	7 V
Line fault detection	< 30 nA
Output	
Connection side	control side
Connection	terminals 5-, 7-, 6+, 8+
Current	0 ... 10 mA
Available voltage	0 ... 4.2 V
Fault signal	field voltage < 150 mV or > 4 V, depending on lead disconnected
Reverse polarity protection	for I < 10 mA or U < 20 V
Transfer characteristics	
Accuracy	0.1 %
Deviation	$I_m \geq 1 \text{ mA}$: $\pm 0.1 \%$ of R_m or $\pm 0.1 \Omega$ (the larger value is applicable) $I_m < 1 \text{ mA}$: accuracy reduces in proportion to I_m . e. g. $I_m = 0.1 \text{ mA}$: $\pm 1 \%$ of R_m or 1Ω (the larger value is applicable).
Influence of ambient temperature	$I_m \geq 1 \text{ mA}$, $R_m \geq 100 \Omega$: 0.01 %/K in the range -20 ... +70 °C (-4 ... 158 °F) $I_m < 1 \text{ mA}$ or $R_m < 100 \Omega$: temperature stability reduces in proportion to I_m or R_m
Settling time	≤ 5 ms
Rise time/fall time	≤ 2 ms (10 ... 90%)
Galvanic isolation	
Output/power supply	functional insulation, rated insulation voltage 50 V AC
Indicators/settings	
Display elements	LED
Control elements	DIP switch
Configuration	via DIP switches
Labeling	space for labeling at the front
Directive conformity	
Electromagnetic compatibility	
Directive 2014/30/EU	EN 61326-1:2013 (industrial locations)
Conformity	
Electromagnetic compatibility	NE 21:2017 EN IEC 61326-3-2:2018
Degree of protection	IEC 60529:2001
Protection against electrical shock	UL 61010-1:2012
Ambient conditions	
Ambient temperature	-40 ... 70 °C (-40 ... 158 °F)
Mechanical specifications	
Degree of protection	IP20
Connection	spring terminals
Mass	approx. 100 g
Dimensions	12.5 x 124 x 114 mm (0.5 x 4.9 x 4.5 inch) (W x H x D), housing type A2
Mounting	on 35 mm DIN mounting rail acc. to EN 60715:2001
Data for application in connection with hazardous areas	
EU-type examination certificate	BASEEFA 10 ATEX 0061X
Marking	⊕ II (1)G [Ex ia Ga] IIC ⊕ II (1)D [Ex ia Da] IIIC ⊕ I (M1) [Ex ia Ma] I
Input	[Ex ia Ga] IIC, [Ex ia Da] IIIC, [Ex ia Ma] I
Voltage	U_o 9.5 V
Current	I_o 39.22 mA
Power	P_o 93 mW

Technical Data





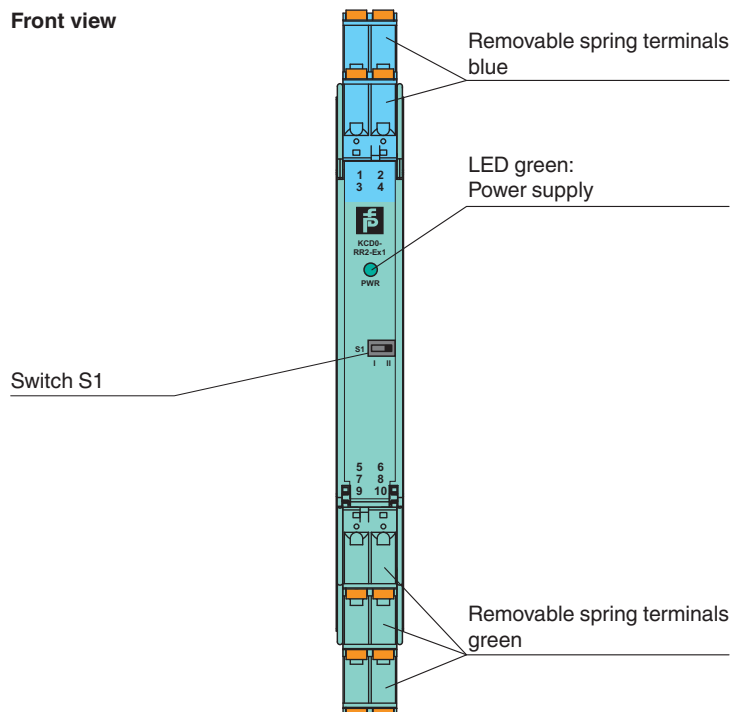

Supply			
Maximum safe voltage	U_m	250 V (Attention! The rated voltage can be lower.)	
Output			
Maximum safe voltage	U_m	250 V (Attention! The rated voltage can be lower.)	
Certificate	BASEEFA 10 ATEX 0062X		
Marking	Ⓔ II 3G Ex ec IIC T4 Gc		
Galvanic isolation			
Input/Output	safe electrical isolation acc. to IEC/EN 60079-11:2007, voltage peak value 375 V		
Input/power supply	safe electrical isolation acc. to IEC/EN 60079-11:2007, voltage peak value 375 V		
Directive conformity			
Directive 2014/34/EU	EN IEC 60079-0:2018 , EN 60079-7:2015+A1:2018 , EN 60079-11:2012		
International approvals			
FM approval			
FM certificate	FM 19 CA 0039 X , FM 19 US 0067 X		
Control drawing	116-0457 (cFMus)		
UL approval			
Control drawing	E106378		
IECEX approval			
IECEX certificate	IECEX BAS 10.0024X IECEX BAS 10.0025X		
IECEX marking	[Ex ia Ga] IIC , [Ex ia Da] IIIC , [Ex ia Ma] I Ex ec IIC T4 Gc		
General information			
Supplementary information	Observe the certificates, declarations of conformity, instruction manuals, and manuals where applicable. For information see www.pepperl-fuchs.com .		

Assembly





Front view



Matching System Components

	KFD2-EB2	Power Feed Module
	UPR-03	Universal Power Rail with end caps and cover, 3 conductors, length: 2 m
	UPR-03-M	Universal Power Rail with end caps and cover, 3 conductors, length: 1,6 m
	UPR-03-S	Universal Power Rail with end caps and cover, 3 conductors, length: 0.8 m
	K-DUCT-BU	Profile rail, wiring comb field side, blue
	K-DUCT-BU-UPR-03	Profile rail with UPR-03- * insert, 3 conductors, wiring comb field side, blue

Accessories

	KC-STP-5GN	Terminal block for KC modules, 2-pin screw terminal, with test sockets, green
	KC-STP-5BU	Terminal block for KC modules, 2-pin screw terminal, with test sockets, blue
	EBP 2- 5	Insertion bridge for connectors, 2-pin, fully insulated
	KF-CP	Red coding pins, packaging unit: 20 x 6

Configuration

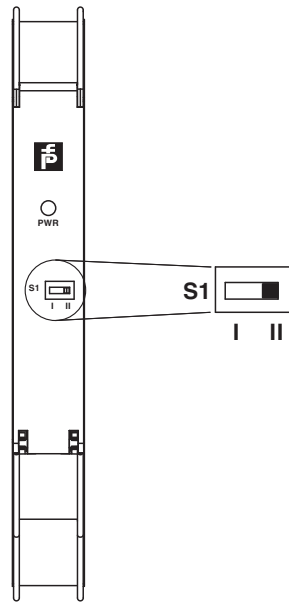

Switch position

Switch	Input	Position
S1	2-wire technique	II
	3-wire technique	I
	4-wire technique	II

Factory settings: switch 1, in position I
 Refer to the next section for connection information.

Additional Information

Function

When a signal converter, a DCS or PLC is connected to terminals 5, 6, 7, and 8 (control side), the measuring current is transferred to terminals 2 and 4 (field side). The resulting voltage at terminals 1, and 3 is transferred to terminals 5, 6, 7, and 8. In the case of fast multiplex input cards, transmission problems might be experienced in connection with low resistance values and/or high sensor currents. For data see rise time. The quoted accuracy is for a 4-wire technique connection. The accuracy in 3-wire technique will depend on the matching of the line resistance.

Connection types control side (safe area)

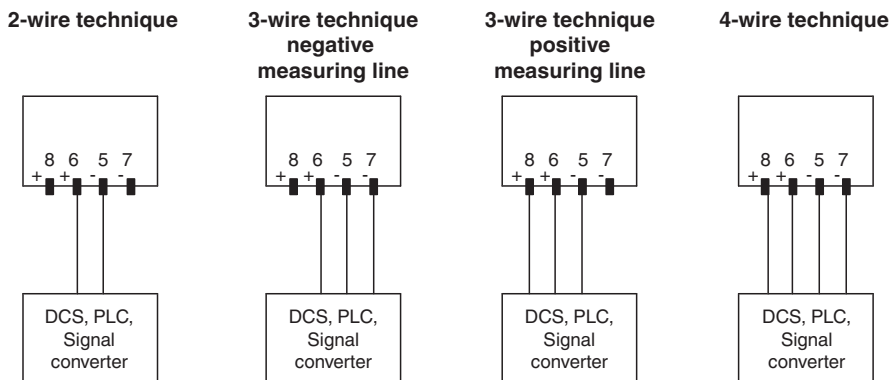

Connection types field side (hazardous area)

The resistance in the hazardous area can be measured with a 2-, 3- or 4-wire technique.

Release date: 2021-12-13 Date of issue: 2021-12-13 Filename: 70103018_eng.pdf

- 2-wire technique:
Link terminals 1 and 2 and terminals 3 and 4. Connect the resistance to terminal 4 and terminal 2. Switch S1 in the position II.
- 3-wire technique:
Link terminals 1 and 2. Connect the resistance to terminals 3 and 4 and terminal 2. Switch S1 in the position I.
- 4-wire technique
Connect the resistance to terminals 3 and 4 and terminals 1 and 2. Switch S1 in the position II.

Measurement range

The resistance repeater can convey a maximum of 10 mA and a maximum of 4.2 V. The maximum connectable resistance value can be calculated with the following equation: resistance value = 4.2 V / measuring current

The measuring current is determined by control.

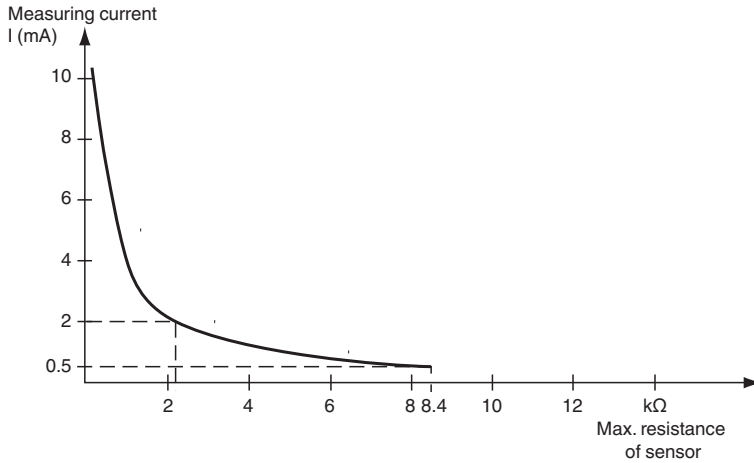

An example of the maximum transferable resistance value:

- 4.2 kΩ at 1 mA measuring current
- 420 Ω at 10 mA measuring current

Line Fault Detection (LFD)

The output will indicate less than 15 Ω or greater than 400 Ω for a lead breakage at terminals 1, 2, 3 or 4 for measuring current of less than or equal to 10 mA i. e. out of range for Pt100.