



RFID read/write device hazardous area

IUH-F190-V1-FR1-01-Ex GUBW1

- Read/Write Head for Hazardous Areas
- Flameproof enclosure
- ATEX-approval for zone 1 and zone 21
- For connection to IDENTControl control interface
- Multi-tag reading increases productivity

UHF RFID read/write device for IDENTControl, Europe, hazardous areas



Application

This product is a wireless device and may be operated only in the country for which a transmission license exists. Information regarding transmission licenses can be found on the datasheet for the product. If a product is released to a customer in a country for which there is no transmission license, the product may be operated only in the country for which a transmission license exists. If a product does not correspond to the legal requirements in force in the EU but is released to a purchaser within the EU, the product is intended for use solely in the destination country of the end customer outside of the EU for which a transmission license exists. The product may therefore under no circumstances be used directly by the purchaser or released to third parties for the purpose of distribution, application or use on the market within the EU as part of a commercial activity. In the event of an infringement, the purchaser is obliged to indemnify the supplier against any resulting damages, costs, penalty payments and other expenses.

Dimensions

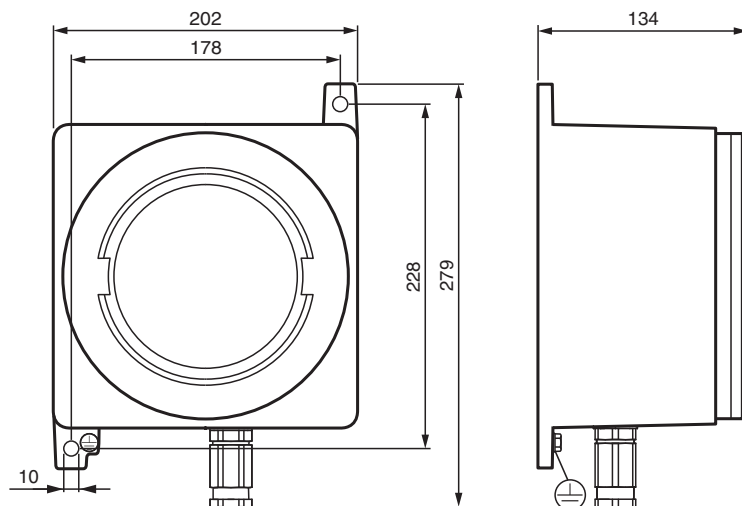

Technical Data

General specifications

Operating frequency	865 ... 868 MHz: EU, Turkey Transmission licenses for other countries on request
Emitted power	3 ... 1000 mW ERP adjustable
Operating distance	typ. 2 m

Indicators/operating means

LED green	Power on
LED yellow	Read/write operation successful
LED blue	Transmission mode

Technical Data

Electrical specifications		
Power consumption	P_0	$\leq 9 \text{ W}$
Supply		from the IDENTControl
Directive conformity		
Radio equipment		
Directive 2014/53/EU		EN 301489-1 EN 301489-3 EN 302208 EN 62368-1 EN 62311 EN 50364
RoHS		
Directive 2011/65/EU (RoHS)		IEC/EN 63000
Standard conformity		
Degree of protection		EN 60529
RFID		ISO/IEC 18000-63
Approvals and certificates		
IECEX approval		IECEX INE 14.0042X
ATEX approval		INERIS 14 ATEX 0035X Device type: GUBW1.D.CP-IUH-F190-V1-FR1-01 Device number: 70117534
Marking		⊕ II 2 GD Ex db IIC T6 Gb Ex tb IIIC T85°C Db
Ambient conditions		
Ambient temperature		-20 ... 60 °C (-4 ... 140 °F) (Operation with nontransmission periods, adjustable) -20 ... 50 °C (-4 ... 122 °F) (Continuous transmission mode)
Storage temperature		-40 ... 85 °C (-40 ... 185 °F)
Mechanical specifications		
Housing length		279 mm
Housing width		202 mm
Housing height		134 mm
Degree of protection		IP66
Connection		Terminal block with screw connection Max. clamping range 0.13 mm ² ... 2.5 mm ² M20 barrier gland for unarmored cables, clamping range 3 mm ... 8.5 mm
Material		
Housing		Seawater-resistant aluminum
Installation		
Distance between two heads		Multiplex on: $\geq 155 \text{ mm}$ Multiplex off: $\geq 350 \text{ mm}$
Mass		approx. 7300 g

Connection

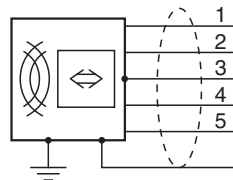
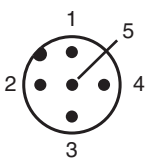











+
 A
 -
 B
 do not connect
 Shield

Accessories

	IC-KP-B17-AIDA1	IDENTControl control interface with Ethernet interface for TCP/IP, PROFINET, EtherNet/IP, and MODBUS TCP protocols
---	------------------------	--

Accessories

	IC-KP2-2HRX-2V1	Control interface unit IDENTControl Compactwith serial interface RS-232 and RS-485
	IC-KP2-2HB6-V15B	Control interface unit IDENTControl Compact with interface for PROFIBUS DP
	IC-KP2-2HB17-2V1D	IDENTControl Compact control interface with Ethernet interface for TCP/IP, PROFINET, EtherNet/IP, and MODBUS TCP protocols
	IC-KP2-2HB21-2V1D	Control interface unit IDENTControl Compact with EtherCAT interface
	IUC76-F157-T17-M-FR1	Data carrier for standard applications
	IUC76-F157-T18-M-FR1	Data carrier for paint shop applications
	IUC77-25L100-GBL 1000pcs	Data carrier
	IUC77-28L90-M-FR1 25pcs	Data carrier
	IUC77-34-M-FR1 10pcs	Data carrier
	IUC77-50-FR1 10pcs	Data carrier