

Retroreflective sensor

OBR5500-18GM60-E4

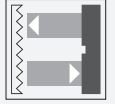

- Strong metallic housing in cylindrical shape M18 x 1
- Not sensitive to ambient light
- Degree of protection IP67
- Very high detection range

Retroreflective sensor



Function

The optical sensors of this series have an M18 threaded housing that is optionally available in plastic or metal. The sensors are robust and versatile. Focusing on the essential requirements simplifies selection and commissioning, saving time and costs.

Dimensions

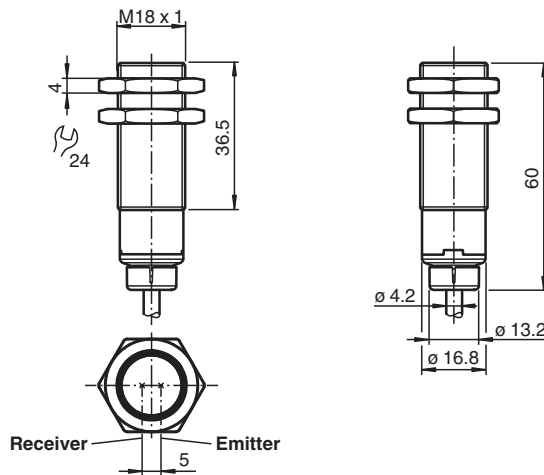

Technical Data

General specifications

Effective detection range	0 ... 5.5 m
Reflector distance	0 ... 5.5 m
Threshold detection range	7.8 m
Reference target	reflector C110-2
Light source	LED
Light type	modulated visible red light
Polarization filter	yes
Diameter of the light spot	approx. 350 mm at 5.5 m
Opening angle	approx. 2.6 °
Optical face	frontal
Ambient light limit	EN 60947-5-2 20000 Lux

Release date: 2022-05-12 Date of issue: 2022-05-12 Filename: 70113328-100029_eng.pdf

Technical Data

Functional safety related parameters		
MTTF _d		962 a
Mission Time (T _M)		20 a
Diagnostic Coverage (DC)		0 %
Indicators/operating means		
Operation indicator		LED green: on - power on flashing (4 Hz) - short circuit
Function indicator		Yellow LED: Permanently lit - light path clear Permanently off - object detected Flashing (4 Hz) - insufficient operating reserve
Control elements		light/dark on electrically switchable
Electrical specifications		
Operating voltage	U _B	10 ... 30 V DC
Ripple		max. 10 %
No-load supply current	I ₀	< 25 mA
Protection class		III
Output		
Switching type		The switching type of the sensor is adjustable. The default setting is: Q - Pin4: NPN output / dark-on L/D-On - WH: Low-active input
Signal output		1 NPN output, short-circuit protected, reverse polarity protected, open collector
Switching voltage		max. 30 V DC
Switching current		max. 100 mA , resistive load
Voltage drop	U _d	≤ 2 V DC
Switching frequency	f	500 Hz
Response time		≤ 1 ms
Conformity		
Product standard		EN 60947-5-2
Approvals and certificates		
UL approval		E87056 , cULus Listed , class 2 power supply , type rating 1
Ambient conditions		
Ambient temperature		-40 ... 60 °C (-40 ... 140 °F)
Storage temperature		-40 ... 70 °C (-40 ... 158 °F)
Mechanical specifications		
Degree of protection		IP67
Connection		2 m fixed cable
Material		
Housing		brass, nickel-plated
Optical face		PMMA
Cable		PVC
Mass		approx. 70 g

Connection

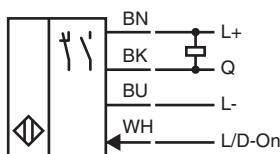

Indication

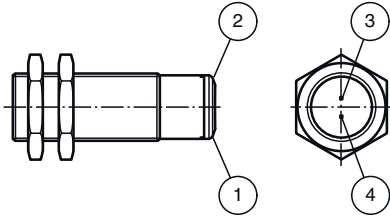

1	Operating display	green
2	Signal display	yellow
3	Emitter	
4	Receiver	

Characteristic Curve

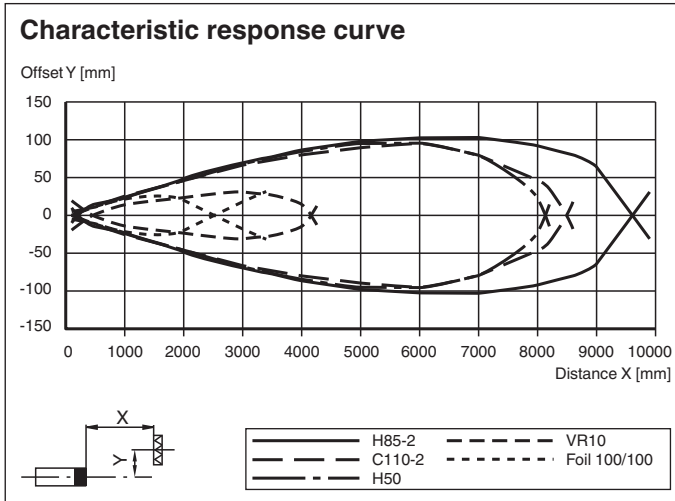

Relative received light strength

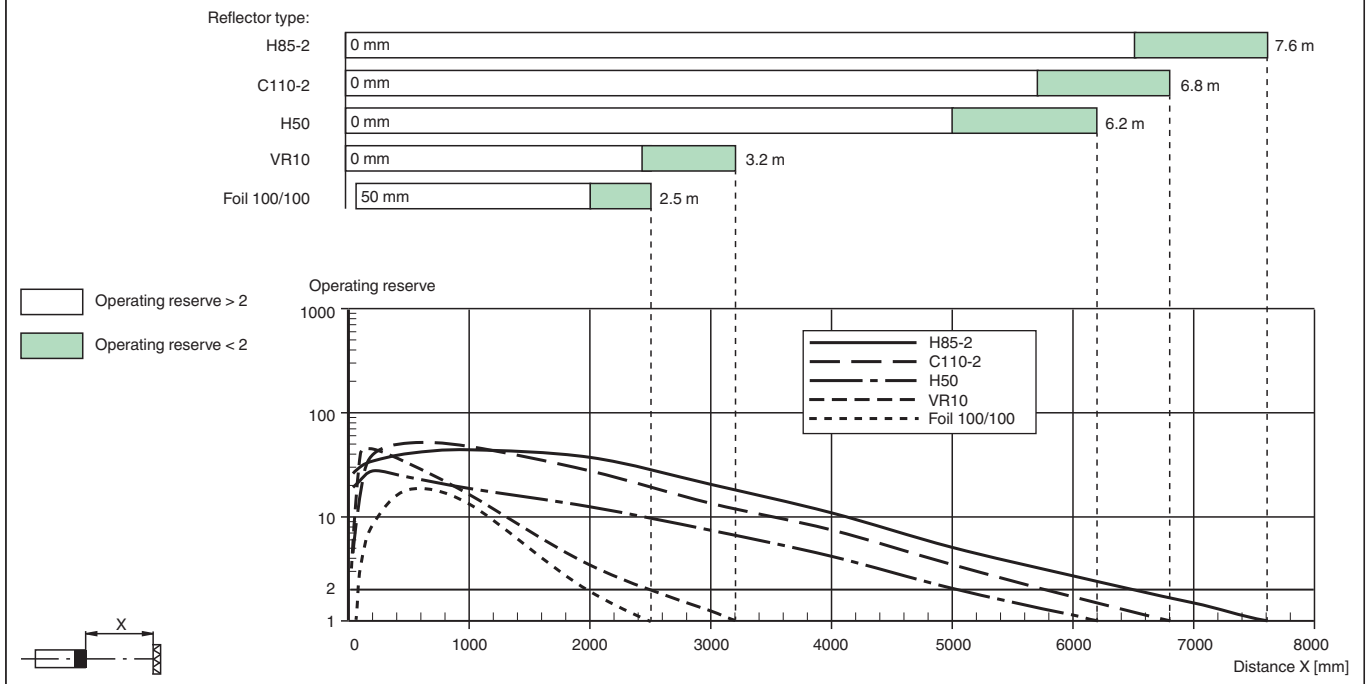









Accessories

	BF 18	Mounting flange, 18 mm
	CPZ18B03	Mounting Bracket with swivel nut

Release date: 2022-05-12 Date of issue: 2022-05-12 Filename: 70113328-100029_eng.pdf

Accessories

	BF 18-F	Plastic mounting adapter, 18 mm
	BF 5-30	Universal mounting bracket for cylindrical sensors with a diameter of 5 ... 30 mm
	OMH-04	Mounting aid for round steel \varnothing 12 mm or sheet 1.5 mm ... 3 mm
	REF-H85-2	Reflector, rectangular 84.5 mm x 84.5 mm, mounting holes
	REF-C110-2	Reflector, round \varnothing 84 mm, central mounting hole
	REF-H50	Reflector, rectangular 51 mm x 61 mm, mounting holes, fixing strap
	REF-VR10	Reflector, rectangular 60 mm x 19 mm, mounting holes
	OFR-100/100	Reflective tape 100 mm x 100 mm