



## Triangulation sensor (BGS)

### OBT150-18GK40-E0-V1



- Short design in M18 plastic housing
- Adjustable background suppression
- Not sensitive to ambient light
- Degree of protection IP67
- High operating distance

Triangulation sensor with background suppression



## Function

The optical sensors of this series have an M18 threaded housing that is optionally available in plastic or metal.

The sensors are robust and versatile.

Focusing on the essential requirements simplifies selection and commissioning, saving time and costs.

## Dimensions

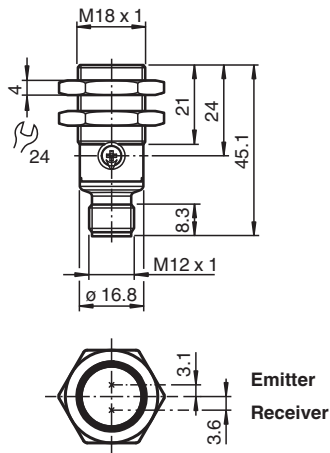

## Technical Data

### General specifications

Detection range	10 ... 150 mm
Detection range min.	10 ... 40 mm
Detection range max.	12 ... 150 mm
Adjustment range	40 ... 150 mm
Reference target	standard white, 100 mm x 100 mm
Light source	LED
Light type	modulated visible red light
Black-white difference (6 %/90 %)	< 10 % at 150 mm
Diameter of the light spot	approx. 6 mm at detection range 150 mm
Opening angle	approx. 2 °
Optical face	frontal

## Technical Data

Ambient light limit		EN 60947-5-2 100000 Lux
Hysteresis	H	< 2 %
<b>Functional safety related parameters</b>		
MTTF <sub>d</sub>		1734 a
Mission Time (T <sub>M</sub> )		20 a
Diagnostic Coverage (DC)		0 %
<b>Indicators/operating means</b>		
Operation indicator		LED green: on - power on flashing (4 Hz) - short circuit
Function indicator		LED yellow: constantly on - object detected constantly off - object not detected
Control elements		sensitivity adjustment
<b>Electrical specifications</b>		
Operating voltage	U <sub>B</sub>	10 ... 30 V DC
Ripple		max. 10 %
No-load supply current	I <sub>0</sub>	< 25 mA
Protection class		III
<b>Output</b>		
Switching type		Q - Pin4: NPN normally open / light-on
Signal output		1 NPN output, short-circuit protected, reverse polarity protected, open collector
Switching voltage		max. 30 V DC
Switching current		max. 100 mA , resistive load
Voltage drop	U <sub>d</sub>	≤ 1.5 V DC
Switching frequency	f	500 Hz
Response time		≤ 1 ms
<b>Conformity</b>		
Product standard		EN 60947-5-2
<b>Approvals and certificates</b>		
UL approval		E87056 , cULus Listed , class 2 power supply , type rating 1
<b>Ambient conditions</b>		
Ambient temperature		-40 ... 60 °C (-40 ... 140 °F)
Storage temperature		-40 ... 70 °C (-40 ... 158 °F)
<b>Mechanical specifications</b>		
Degree of protection		IP67
Connection		3-pin, M12 x 1 connector
<b>Material</b>		
Housing		PC (Polycarbonate)
Optical face		PMMA
Connector		plastic
Mass		approx. 8 g
<b>Dimensions</b>		
Length		45.1 mm
Diameter		18 mm
Thread size		M18

**Connection Assignment**

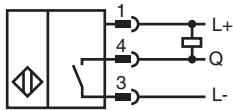

**Connection Assignment**

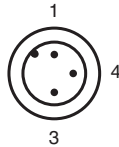

Wire colors in accordance with EN 60947-5-2

- 1 | BN (brown)
- 3 | BU (blue)
- 4 | BK (black)

**Indication**

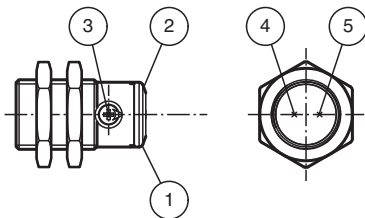

1	Operating display	green
2	Signal display	yellow
3	Sensitivity adjustment	
4	Emitter	
5	Receiver	

**Characteristic Curve**

**Characteristic response curve**

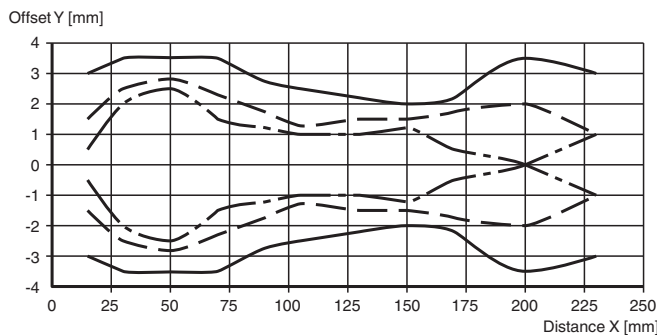

Release date: 2024-06-28 Date of issue: 2024-06-28 Filename: 70113328-100092\_eng.pdf

## Characteristic Curve

### Detection ranges

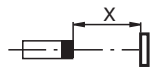
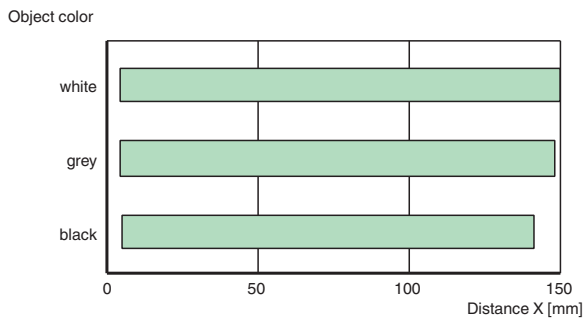

### Difference in detection distance

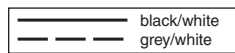
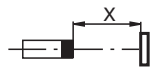
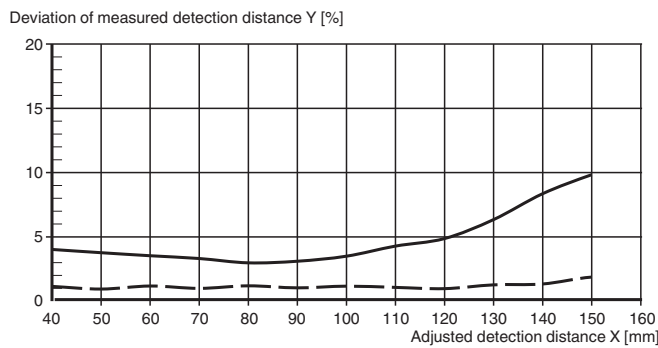

### Light spot diameter

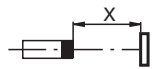
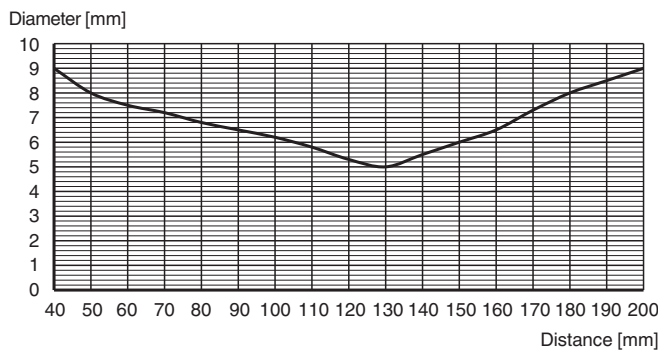

Release date: 2024-06-28 Date of issue: 2024-06-28 Filename: 70113328-100092\_eng.pdf