



Diffuse mode sensor OBD450-18GM40A-E0-V1



- Strong metallic housing in cylindrical shape M18 x 1
- Operating distance adjustable
- Not sensitive to ambient light
- Degree of protection IP67
- High operating distance

Diffuse mode sensor



Function

The optical sensors of this series have an M18 threaded housing that is optionally available in plastic or metal. The sensors are robust and versatile. Focusing on the essential requirements simplifies selection and commissioning, saving time and costs.

Dimensions

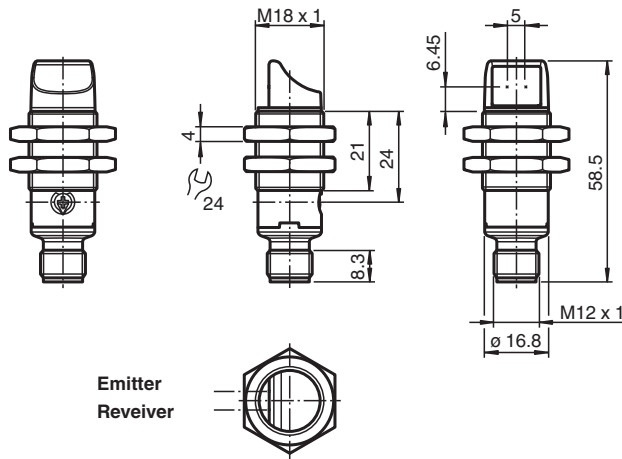

Emitter
Receiver

Technical Data

General specifications

Detection range	0 ... 450 mm
Detection range min.	0 ... 30 mm
Detection range max.	0 ... 450 mm
Adjustment range	30 ... 450 mm
Reference target	standard white 200 mm X 200 mm
Light source	LED
Light type	modulated visible red light
Diameter of the light spot	approx. 30 mm at 450 mm
Opening angle	approx. 2.6 °
Optical face	lateral
Ambient light limit	EN 60947-5-2 20000 Lux

Technical Data

Hysteresis	H	< 15 %
Functional safety related parameters		
MTTF _d		1289 a
Mission Time (T _M)		20 a
Diagnostic Coverage (DC)		0 %
Indicators/operating means		
Operation indicator		LED green: on - power on flashing (4 Hz) - short circuit
Function indicator		LED yellow: constantly on - object detected constantly off - object not detected
Control elements		sensitivity adjustment
Electrical specifications		
Operating voltage	U _B	10 ... 30 V DC
Ripple		max. 10 %
No-load supply current	I ₀	< 25 mA
Protection class		III
Output		
Switching type		Q - Pin4: NPN normally open / light-on
Signal output		1 NPN output, short-circuit protected, reverse polarity protected, open collector
Switching voltage		max. 30 V DC
Switching current		max. 100 mA , resistive load
Voltage drop	U _d	≤ 1.5 V DC
Switching frequency	f	500 Hz
Response time		≤ 1 ms
Conformity		
Product standard		EN 60947-5-2
Approvals and certificates		
UL approval		E87056 , cULus Listed , class 2 power supply , type rating 1
Ambient conditions		
Ambient temperature		-40 ... 60 °C (-40 ... 140 °F)
Storage temperature		-40 ... 70 °C (-40 ... 158 °F)
Mechanical specifications		
Degree of protection		IP67
Connection		3-pin, M12 x 1 connector
Material		
Housing		brass, nickel-plated
Optical face		PMMA
Connector		plastic
Mass		approx. 16 g

Connection

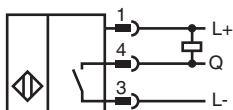

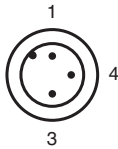

Wire colors in accordance with EN 60947-5-2

1	BN	(brown)
3	BU	(blue)
4	BK	(black)

Indication

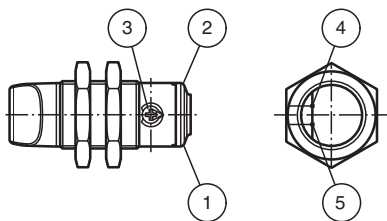

1	Operating display	green
2	Signal display	yellow
3	Sensitivity adjustment	
4	Emitter	
5	Receiver	

Characteristic Curve

Characteristic response curve

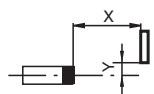
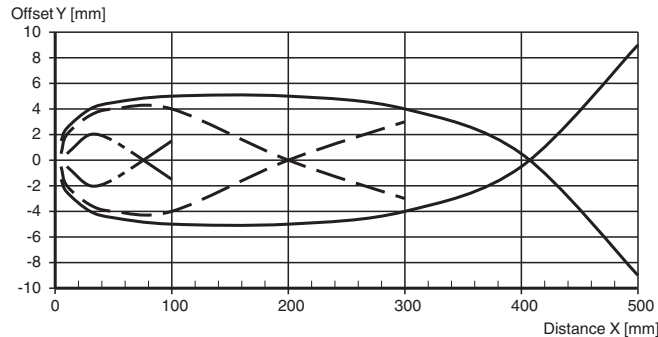

	white
	grey
	black

Relative received light strength

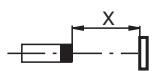
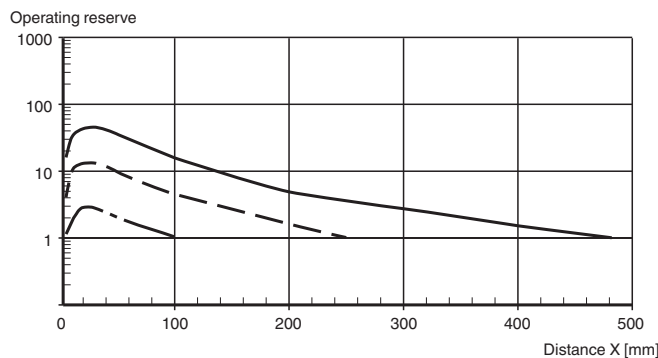





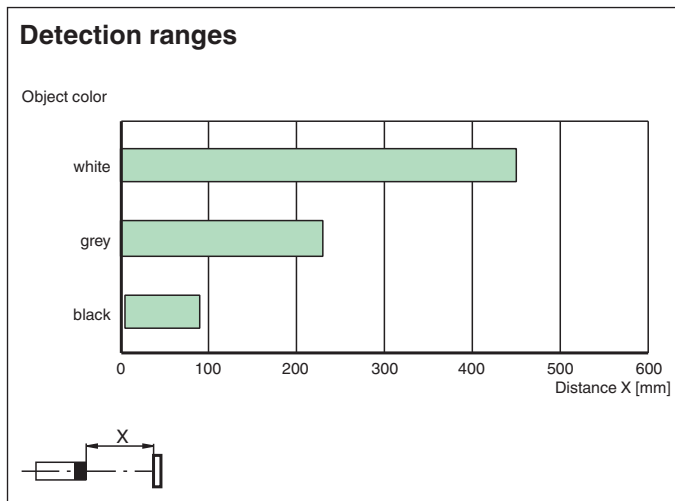

	white
	grey
	black

Release date: 2022-05-12 Date of issue: 2022-05-12 Filename: 70113328-100107_eng.pdf

Characteristic Curve



Accessories

	V1-G-2M-PUR	Female cordset single-ended M12 straight A-coded, 4-pin, PUR cable grey
	V1-W-2M-PUR	Female cordset single-ended M12 angled A-coded, 4-pin, PUR cable grey
	OMH-04	Mounting aid for round steel \varnothing 12 mm or sheet 1.5 mm ... 3 mm
	BF 18	Mounting flange, 18 mm
	BF 18-F	Plastic mounting adapter, 18 mm
	BF 5-30	Universal mounting bracket for cylindrical sensors with a diameter of 5 ... 30 mm
	CPZ18B03	Mounting Bracket with swivel nut