



Retroreflective sensor ML100-54-F-A025-SET



- No controls
- Miniature design
- Easy to use
- Clearly visible LEDs for Power ON, switching state and weak signal indication
- Very bright, highly visible light spot
- Full metal thread mounting
- Not sensitive to ambient light
- Optimized for small distances to any reflector
- Mounting optical reflective films down to a distance of 20 mm possible

Retroreflective sensor with polarization filter, plastic housing, 3 m detection range, red light, light on, DC version, PNP output, fixed cable with M8 plug



Function

The optical sensors of this series are suitable for both standard and demanding applications. The series features a miniature housing design, two M3 metal-threaded mounting holes and a highly visible LED status indicator. Each device is equipped with a sensitivity adjuster and a light-on/dark-on changeover switch for increased flexibility. A wide variety of versions are available in both infrared light and red light with PowerBeam for easy alignment. Special versions with BlueBeam are suitable for challenging applications like those in the solar and battery industries.

Dimensions

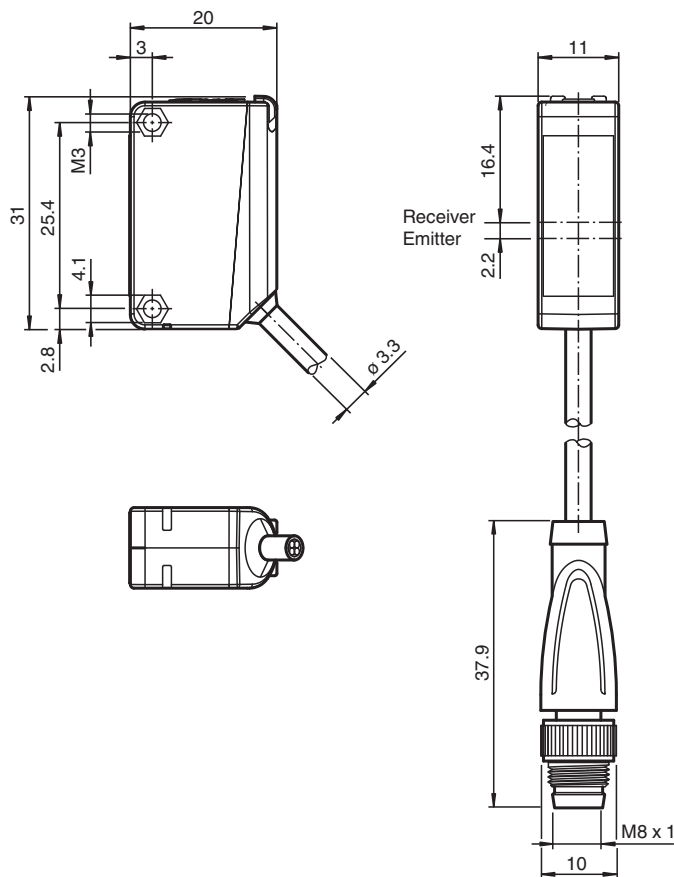

Technical Data

General specifications

Effective detection range	0 ... 2.7 m
Reflector distance	0.02 ... 2.7 m (0.02 ... 1 m on OFR-100/100 optical reflective film)
Threshold detection range	3 m
Reference target	H50 reflector
Light source	LED
Light type	modulated visible red light
Polarization filter	yes
Diameter of the light spot	approx. 200 mm at a distance of 3 m
Opening angle	approx. 4 °
Optical face	frontal
Ambient light limit	EN 60947-5-2

Functional safety related parameters

MTTF _d	860 a
Mission Time (T _M)	20 a
Diagnostic Coverage (DC)	0 %

Indicators/operating means

Operation indicator	LED green: power on
Function indicator	LED yellow: lights up when receiving the light beam ; flashes when falling short of the operating reserve; OFF when light beam is interrupted

Electrical specifications

Operating voltage	U _B	10 ... 30 V DC
-------------------	----------------	----------------

Technical Data

Ripple		max. 10 %
No-load supply current	I_0	< 20 mA
Output		
Switching type		light-on
Signal output		1 PNP output, short-circuit protected, reverse polarity protected, open collector
Switching voltage		max. 30 V DC
Switching current		max. 100 mA , resistive load
Voltage drop	U_d	≤ 1.5 V DC
Switching frequency	f	1000 Hz
Response time		0.5 ms
Conformity		
Product standard		EN 60947-5-2
Approvals and certificates		
UL approval		cULus Listed, Class 2 Power Source or listed Power Supply with a limited voltage output with (maybe integrated) fuse (max. 3.3 A according UL248), Type 1 enclosure
CCC approval		CCC approval / marking not required for products rated ≤ 36 V
Ambient conditions		
Ambient temperature		-30 ... 60 °C (-22 ... 140 °F)
Storage temperature		-40 ... 70 °C (-40 ... 158 °F)
Mechanical specifications		
Housing width		11 mm
Housing height		31 mm
Housing depth		20 mm
Degree of protection		IP67
Connection		1500 mm fixed cable with 4-pin, M8 x 1 connector
Material		
Housing		PC (Polycarbonate)
Optical face		PMMA
Mass		approx. 50 g
Tightening torque, fastening screws		0.6 Nm
Cable length		1.5 m
Accessories		
Accessories provided		2 x M3 x 12 phillips-slotted SEM pan head machine screws with flat washer and spring washer , Stainless steel A2 , passivated

Connection

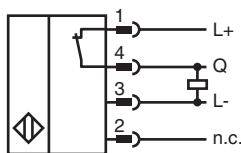

Connection Assignment



Connection Assignment

Wire colors in accordance with EN 60947-5-2

1	BN	(brown)
2	WH	(white)
3	BU	(blue)
4	BK	(black)

Indication

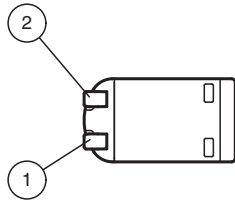

1	Signal display	yellow
2	Operating display	green

Characteristic Curve

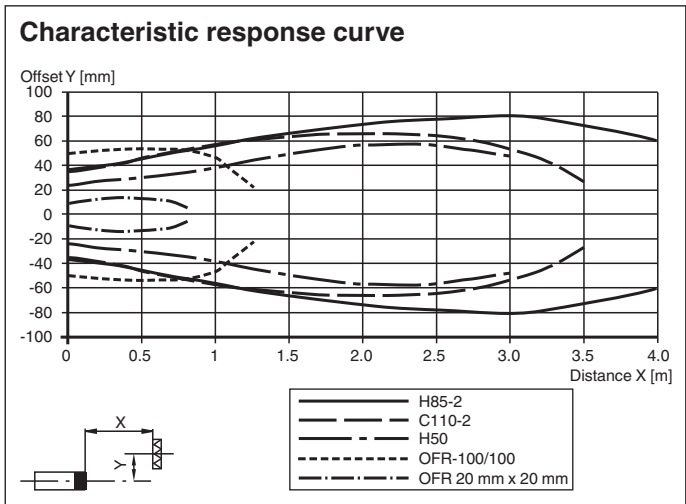

Release date: 2023-06-15 Date of issue: 2023-06-15 Filename: 70120400_eng.pdf

Characteristic Curve

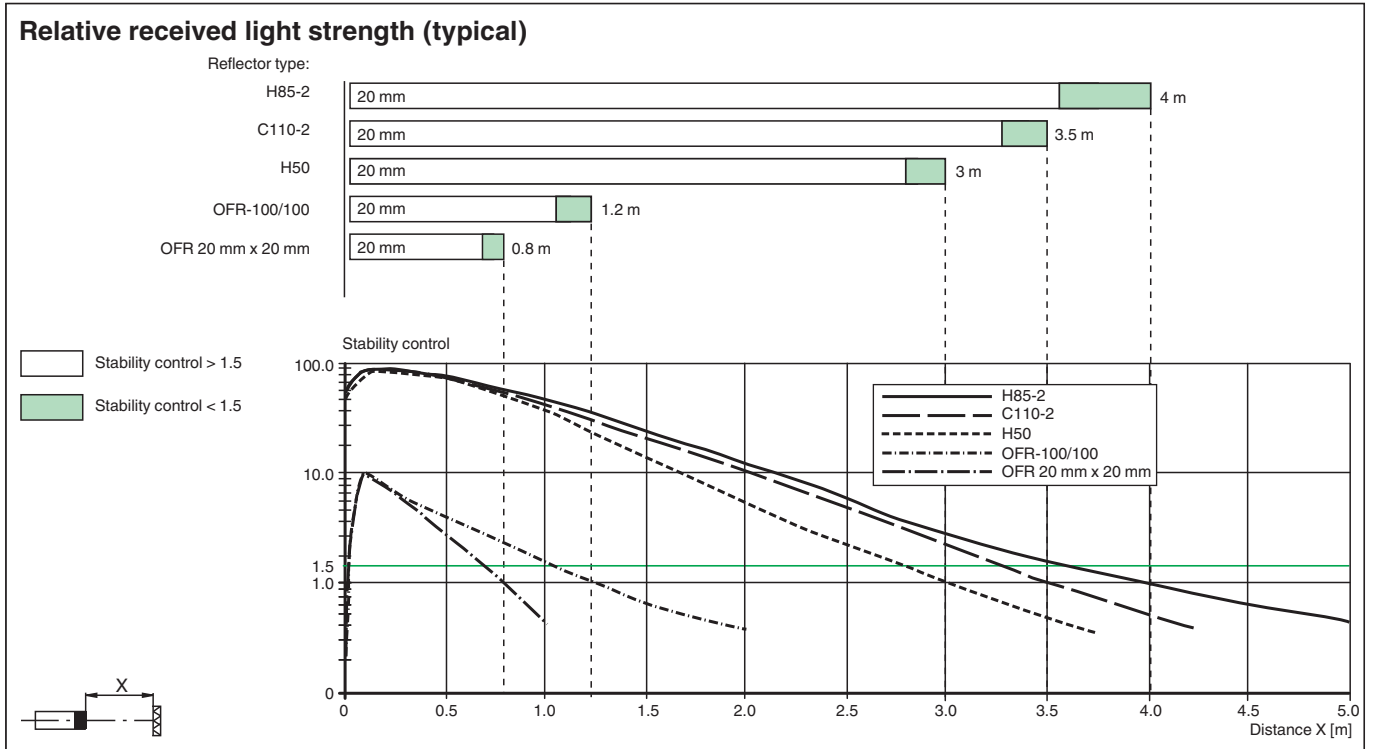





Accessories

	OMH-ML100-09	Mounting aid for round steel \varnothing 12 mm or sheet 1.5 mm ... 3 mm
	OMH-F10-ML100	Mounting aid for ML100 series
	OMH-ML100-01	Mounting aid for ML100 series, mounting bracket
	OMH-ML100-02	Mounting aid for ML100 series, mounting bracket
	OMH-ML100-03	Mounting aid for round steel \varnothing 12 mm or sheet 1.5 mm ... 3 mm
	OMH-ML100-04	Mounting aid for ML100 series, mounting bracket
	OMH-ML100-05	Mounting aid for ML100 series, mounting bracket
	OMH-10	Mounting aid for ML100 series
	REF-C110-2	Reflector, round \varnothing 84 mm, central mounting hole
	REF-H60-2	Reflector with mounting holes
	REF-H33	Reflector with screw fixing

Release date: 2023-06-15 Date of issue: 2023-06-15 Filename: 70120400_eng.pdf

Accessories

	OFR-70-2	Reflective tape 70 mm x 70 mm
	OMH-ML100-08	Mounting aid for ML100 series, Snap-in
	REF-H85-2	Reflector, rectangular 84.5 mm x 84.5 mm, mounting holes
	REF-H50	Reflector, rectangular 51 mm x 61 mm, mounting holes, fixing strap
	OFR-100/100	Reflective tape 100 mm x 100 mm

System Description

System Description

The retro-reflective sensor contains both an emitter and a receiver in a single housing. A reflector reflects the light from emitter back to the receiver. If an object interrupts the light beam, the switching function is initiated.

Mounting

Mounting

The sensors can be mounted directly via through-holes or by using a mounting bracket or a clamp component. Mounting brackets and clamp components are available as accessories.

Ensure that the surface is flat to avoid housing distortion during mounting and fixing.

Secure nut and bolt with spring washers to prevent misalignment of the sensor.

Adjusting the Sensor: Apply the operating voltage to the sensor. The power indicator lights green.

Mount a suitable reflector opposite the retroreflective sensor. Align the sensor (without object) roughly with the reflector. Then adjust the sensor to the reflector by tilting it horizontally and vertically until the yellow signal indicator is permanently lights up. If the alignment is inaccurate, the yellow signal indicator flashes.

Commissioning

Commissioning

Check Object Detection: Check as follows if the sensor detects objects as intended.

Position the object in the beam path of the sensor.

Once the object is detected, the yellow signal indicator goes out. As soon as the object leaves the beam path of the sensor, the yellow signal indicator permanently lights up again.

Maintenance

Maintenance

Cleaning: If reception deteriorates, e. g. due to dirt, the yellow signal indicator of the receiver flashes. Clean the optical interfaces of the sensor (e. g. lenses) at regular intervals.

Servicing: Check the mounting screw connections and the electrical plug connections regularly.