

Socket 16A, 4 pole, red

PS16-440600



- Ex de and Ex t certified
- Glass-fiber reinforced polyester (GRP) enclosure
- Full equipment certified
- Installation in Zone 1, Zone 2, Zone 21 and Zone 22
- Degree of protection IP66
- Degree of protection ensured by means of bayonet catch
- Low insertion force
- Self-cleaning lamellar contacts



Dimensions

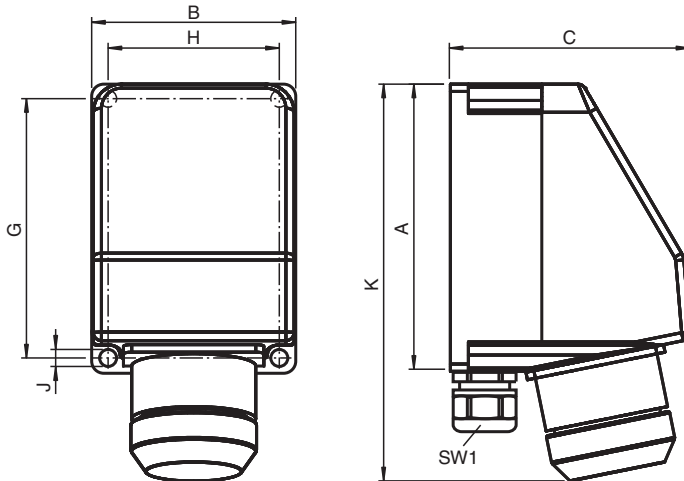

Dimension values see data table.
Image and drawing are generic for this device type and may deviate from the specific variant.

Legend	
A	External dimension
B	External dimension
C	External dimension, depth
G	Mounting holes distance
H	Mounting holes distance
J	Mounting holes diameter
K	Maximum external dimension
SW1	Cable entry

Technical Data

Electrical specifications

Operating voltage	380 ... 415 V
Operating current	16 A max.
Terminal capacity	

Technical Data

Main terminals capacity	2.5 mm ²
Main terminals torque	2.5 Nm
Supply frequency	50/60 Hz
Function	socket
Usage category	AC3: 415 V AC - 16 A
Number of poles	4
Color coding according to IEC 60309	red
Protective contact position according to IEC 60309	6 h
Mechanical specifications	
Cable type	non-armored cables
Cover fixing	
Screws	M4
Number	4
Tightening torque	2.5 Nm
Degree of protection	IP66
Cable entry	
Number of cable entries	2x M25 1x Cable gland , 1x Stopping Plug
Cable entry face B	
M25 clamping range	8 ... 17 mm
Material	
Housing	carbon loaded, antistatic glass-fiber reinforced polyester (GRP)
Finish	inherent color black
Mass	1.2 kg
Dimensions	
External dimension (A)	176 mm
External dimension (B)	123 mm
External dimension (C)	147 mm
Mounting holes distance (G)	163 mm
Mounting holes distance (H)	106 mm
Mounting holes diameter (J)	6 mm
Maximum external dimension (K)	241 mm
Ambient conditions	
Ambient temperature	-40 ... 55 °C (-40 ... 131 °F)
Data for application in connection with hazardous areas	
EU-type examination certificate	SIRA 11 ATEX 1044
Marking	Ⓔ II 2 GD Ex de IIC T6 Gb Ex t IIIC T80 °C Db
International approvals	
IECEx approval	IECEx SIR 11.0026
Conformity	
Degree of protection	EN 60529
Usage category	IEC / EN 60947
CE marking	0102
Plug connection	IEC 60309
General information	
Supplementary information	EC-Type Examination Certificate, Statement of Conformity, Declaration of Conformity, Attestation of Conformity and instructions have to be observed where applicable. For information see www.pepperl-fuchs.com .