

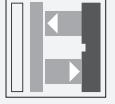

## Triangulation sensor (BGS)

### OBT1250-R202-2EP-V1-IR



- Medium design with versatile mounting options
- Degree of protection IP67
- Mounting on full metal sockets
- Version with infrared light
- Highly visible LEDs for Power ON and switching state
- Easy to use
- Image is generic for this device type and may deviate from the specific variant



## Function

The optical sensors of this series for applications in standard automation have a modern housing design. The sensors are characterized by the many mounting options, easy handling and highly visible LED status indicators. The integrated full metal bushings ensure long-term secure and dimensionally stable mounting.

**Dimensions**

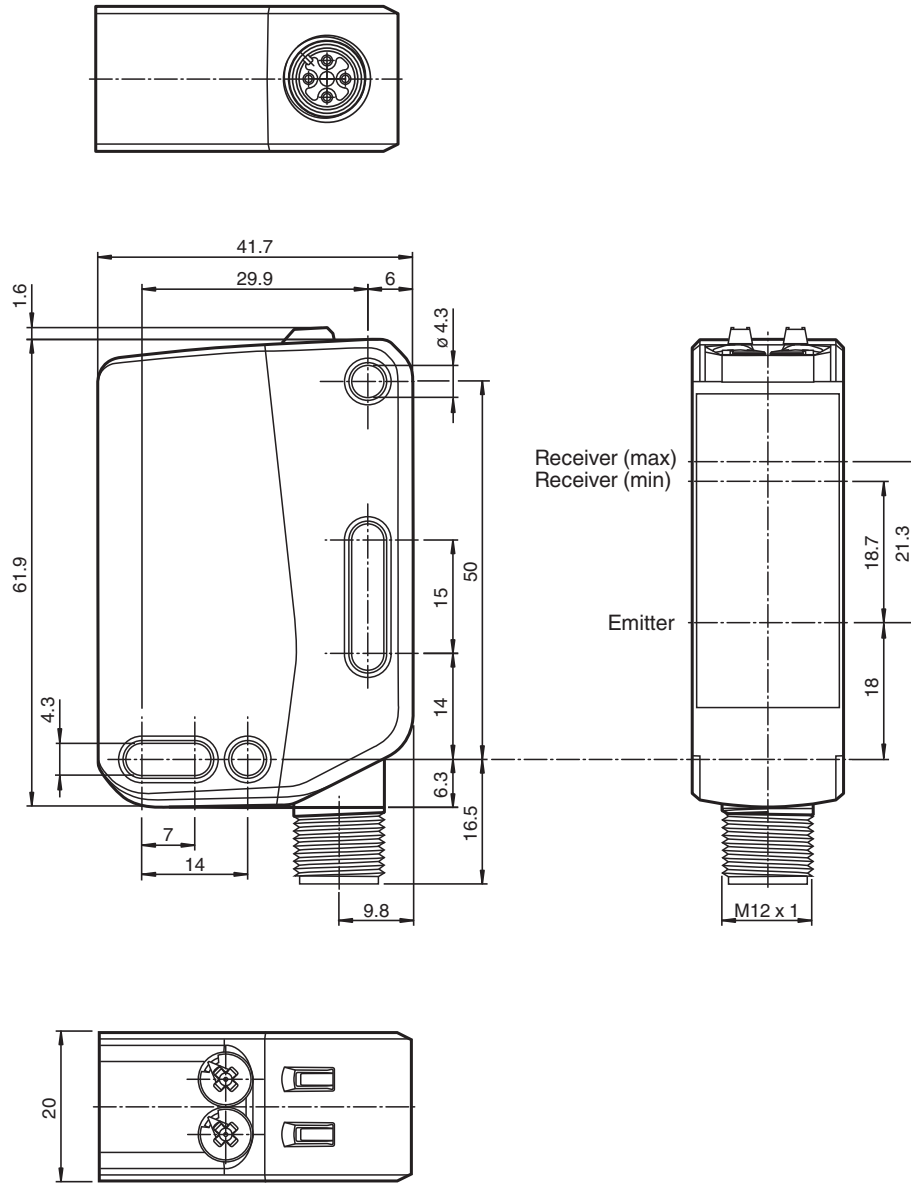

**Technical Data**

**General specifications**

Detection range	0 ... 1250 mm
Detection range min.	0 ... 200 mm
Detection range max.	0 ... 1250 mm
Adjustment range	200 ... 1250 mm
Reference target	standard white, 100 mm x 100 mm
Light source	LED
Light type	modulated infrared light

Release date: 2025-02-18 Date of issue: 2025-02-18 Filename: 70128080-100080\_eng.pdf

## Technical Data

LED risk group labelling		exempt group
Black-white difference (6 %/90 %)		< 35 % at 1250 mm
Diameter of the light spot		approx. 50 mm at a distance of 1250 mm
Opening angle		3 °
Ambient light limit		EN 60947-5-2 : 30000 Lux
<b>Functional safety related parameters</b>		
MTTF <sub>d</sub>		876 a
Mission Time (T <sub>M</sub> )		20 a
Diagnostic Coverage (DC)		0 %
<b>Indicators/operating means</b>		
Operation indicator		LED green: on - power on flashing (4 Hz) - short circuit
Function indicator		LED yellow: constantly on - object detected constantly off - object not detected Flashing (8 Hz) - fault detected, the outputs maintain the status
Control elements		Light-on/dark-on changeover switch
Control elements		Sensing range adjuster
<b>Electrical specifications</b>		
Operating voltage	U <sub>B</sub>	10 ... 30 V DC
Ripple		max. 10 %
No-load supply current	I <sub>0</sub>	< 35 mA at 24 V Operating voltage
Protection class		III
<b>Output</b>		
Switching type		The switching type of the sensor is adjustable. The default setting is: Q - Pin4: NPN normally open / light-on, PNP normally closed / dark-on /Q - Pin2: NPN normally closed / dark-on, PNP normally open / light-on
Signal output		2 push-pull (4 in 1) outputs, complementary, short-circuit proof, reverse polarity protected
Switching voltage		max. 30 V DC
Switching current		max. 100 mA , resistive load
Usage category		DC-12 and DC-13
Voltage drop	U <sub>d</sub>	≤ 1.5 V DC
Switching frequency	f	1000 Hz
Response time		0.5 ms
<b>Conformity</b>		
Product standard		EN 60947-5-2
<b>Approvals and certificates</b>		
UL approval		E87056 , cULus Listed , class 2 power supply , type rating 1
CCC approval		CCC approval / marking not required for products rated ≤36 V
<b>Ambient conditions</b>		
Ambient temperature		-30 ... 60 °C (-22 ... 140 °F)
Storage temperature		-40 ... 70 °C (-40 ... 158 °F)
<b>Mechanical specifications</b>		
Degree of protection		IP67
Connection		4-pin, M12 x 1 connector
<b>Material</b>		
Housing		PC (Polycarbonate)
Optical face		PMMA
Mass		approx. 55 g
<b>Dimensions</b>		
Height		61.9 mm
Width		20 mm
Depth		41.7 mm

## Connection

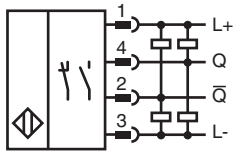

## Assembly

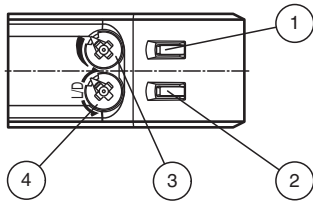

1	Function indicator	YE
2	Operation indicator	GN
3	Sensitivity adjuster	
4	Light-on / dark-on changeover switch	

## Characteristic Curve

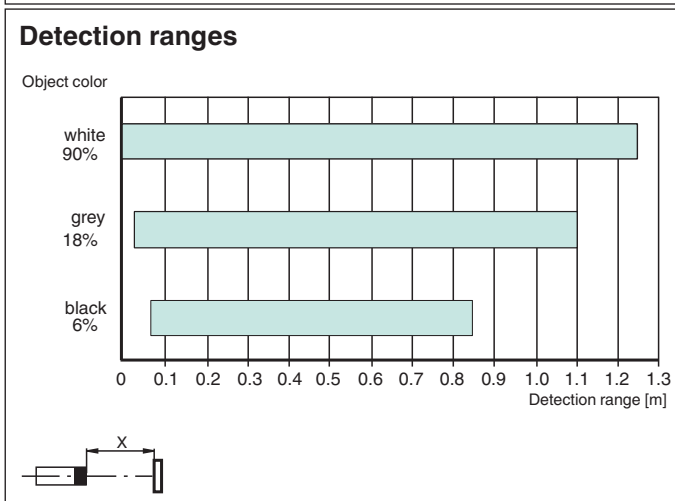
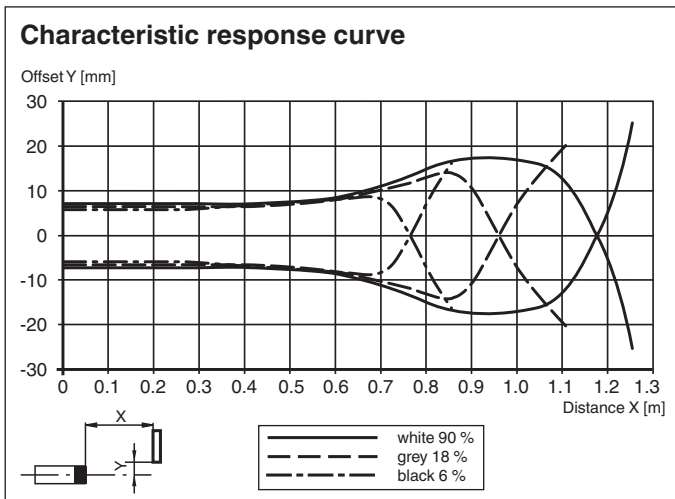

Release date: 2025-02-18 Date of issue: 2025-02-18 Filename: 70128080-100080\_eng.pdf

## Characteristic Curve

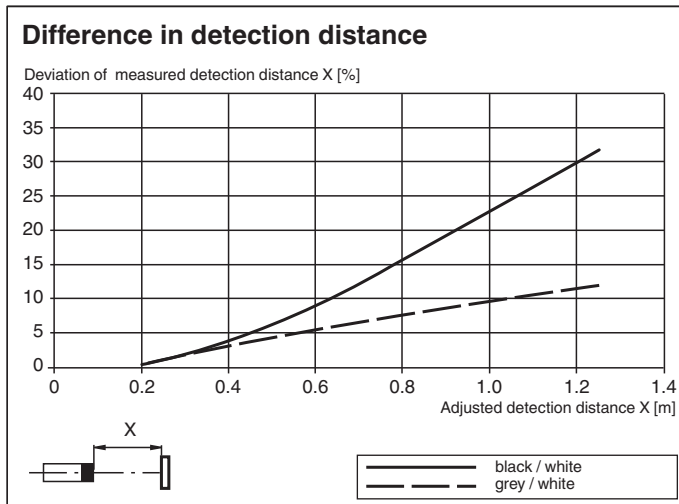

## Commissioning

### Sensing Range / Sensitivity

Turn sensing range / sensitivity adjuster clockwise to increase sensing range / sensitivity.  
 Turn sensing range / sensitivity adjuster counter clockwise to decrease sensing range / sensitivity.  
 The internal end stop signals the end of the adjustment range.

### Light-on / Dark-on Configuration

To set light switching or dark switching, turn the light/dark changeover switch to the end stop:

- clockwise: dark switching
- counterclockwise: light switching