



## Triangulation sensor (BGS) OBT1250-R202-E2-0,3M-V1-Y0081



- Medium design with versatile mounting options
- Degree of protection IP67
- Mounting on full metal sockets
- Very bright, highly visible light spot
- Highly visible LEDs for Power ON and switching state
- Easy to use
- Image is generic for this device type and may deviate from the specific variant



### Function

The optical sensors of this series for applications in standard automation have a modern housing design. The sensors are characterized by the many mounting options, easy handling and highly visible LED status indicators. The integrated full metal bushings ensure long-term secure and dimensionally stable mounting.

**Dimensions**

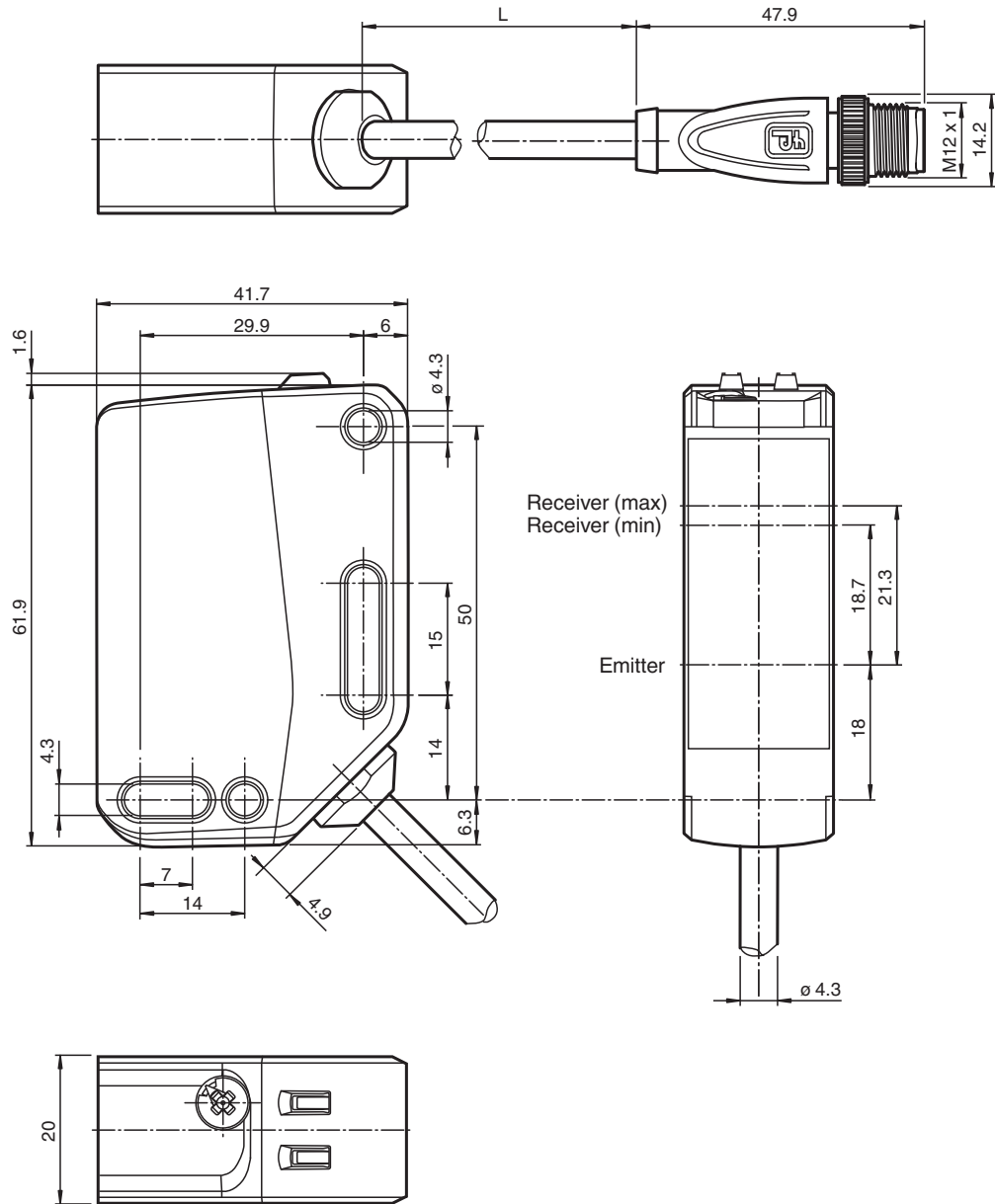

**Technical Data**

General specifications	
Detection range	0 ... 1250 mm
Detection range min.	0 ... 200 mm
Detection range max.	0 ... 1250 mm
Adjustment range	200 ... 1250 mm
Reference target	standard white, 100 mm x 100 mm
Light source	LED
Light type	modulated visible red light

Release date: 2025-02-18 Date of issue: 2025-02-18 Filename: 70128080-100081\_eng.pdf

## Technical Data

LED risk group labelling		exempt group
Black-white difference (6 %/90 %)		< 40 % at 1250 mm
Diameter of the light spot		approx. 50 mm at a distance of 1250 mm
Opening angle		3 °
Ambient light limit		EN 60947-5-2 : 30000 Lux
<b>Functional safety related parameters</b>		
MTTF <sub>d</sub>		876 a
Mission Time (T <sub>M</sub> )		20 a
Diagnostic Coverage (DC)		0 %
<b>Indicators/operating means</b>		
Operation indicator		LED green: on - power on flashing (4 Hz) - short circuit
Function indicator		LED yellow: constantly on - object detected constantly off - object not detected Flashing (8 Hz) - fault detected, the outputs maintain the status
Control elements		Sensing range adjuster
<b>Electrical specifications</b>		
Operating voltage	U <sub>B</sub>	10 ... 30 V DC
Ripple		max. 10 %
No-load supply current	I <sub>0</sub>	< 35 mA at 24 V Operating voltage
Protection class		III
<b>Output</b>		
Switching type		Q - Pin4: PNP normally open / light-on
Signal output		1 PNP output, short-circuit protected, reverse polarity protected ,
Switching voltage		max. 30 V DC
Switching current		max. 100 mA , resistive load
Usage category		DC-12 and DC-13
Voltage drop	U <sub>d</sub>	≤ 1.5 V DC
Switching frequency	f	1000 Hz
Response time		0.5 ms
<b>Conformity</b>		
Product standard		EN 60947-5-2
<b>Approvals and certificates</b>		
UL approval		E87056 , cULus Listed , class 2 power supply , type rating 1
CCC approval		CCC approval / marking not required for products rated ≤36 V
<b>Ambient conditions</b>		
Ambient temperature		-30 ... 60 °C (-22 ... 140 °F)
Storage temperature		-40 ... 70 °C (-40 ... 158 °F)
<b>Mechanical specifications</b>		
Degree of protection		IP67
Connection		300 mm fixed cable with M12 x 1, 4-pin connector
Material		
Housing		PC (Polycarbonate)
Optical face		PMMA
Mass		approx. 70 g
Dimensions		
Height		61.9 mm
Width		20 mm
Depth		41.7 mm
Cable length		0.3 m

## Connection

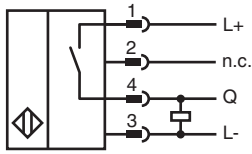

## Connection Assignment

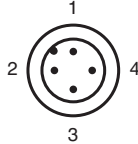

Wire colors in accordance with EN 60947-5-2

1	BN	(brown)
2	WH	(white)
3	BU	(blue)
4	BK	(black)

## Assembly

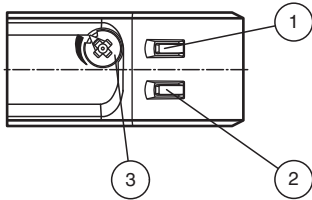

1	Function indicator	YE
2	Operation indicator	GN
3	Sensitivity adjuster	

## Characteristic Curve

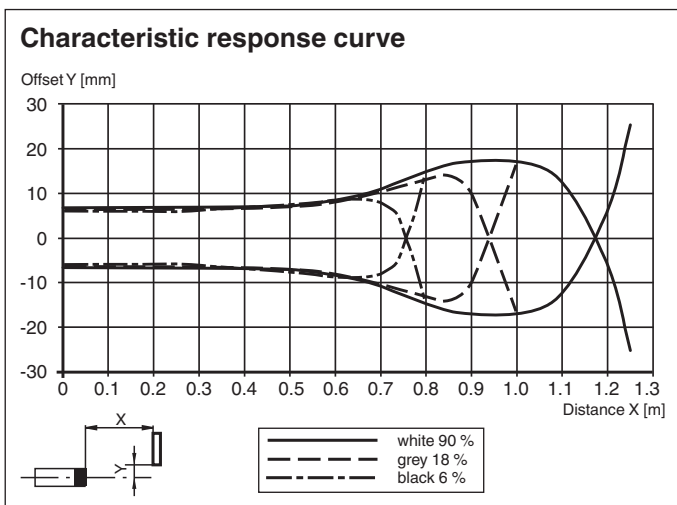

Release date: 2025-02-18 Date of issue: 2025-02-18 Filename: 70128080-100081\_eng.pdf

## Characteristic Curve

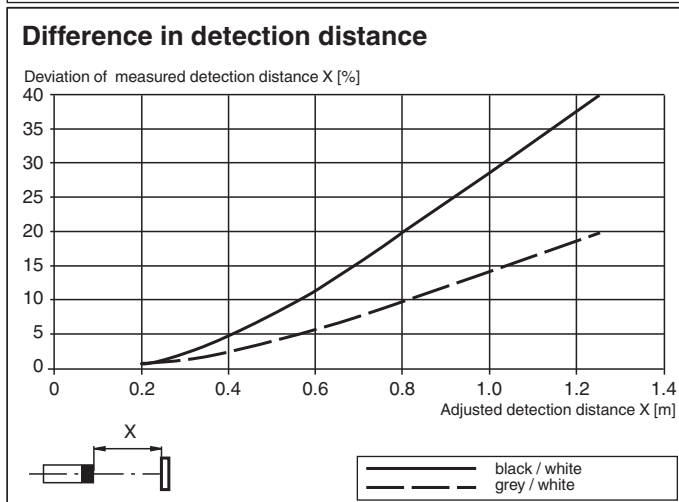
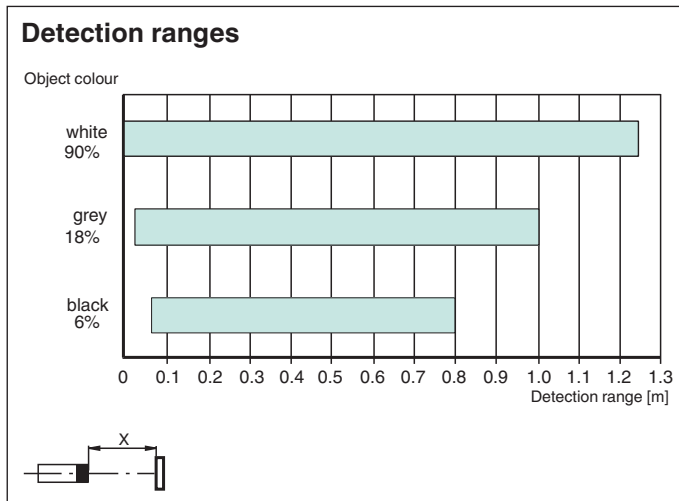

## Commissioning

### Sensing Range / Sensitivity

Turn sensing range / sensitivity adjuster clockwise to increase sensing range / sensitivity.  
 Turn sensing range / sensitivity adjuster counter clockwise to decrease sensing range / sensitivity.  
 The internal end stop signals the end of the adjustment range.