

# Female cordset

## V1-W-OR5M-PUR-A1

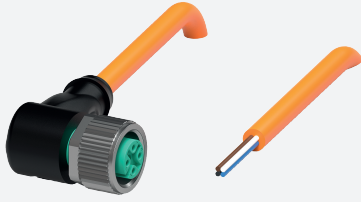

- Improved resistance to weld slag
- Suitable for drag chains and abrasion resistant
- Suitable for robotic applications / torsion resistant
- Degree of protection IP68 / IP69
- Free of paint wetting interfering substances
- Resistant to microbes and hydrolysis
- UL listed for USA and Canada
- Halogen-free
- Meets the VASS6 standard
- Specific design protects against loosening and inaccurate installation

Female cordset single-ended M12 angled A-coded, 4-pin, PUR cable welding-bead resistant orange, UL approved, drag chain suitable, torsion resistant



### Dimensions

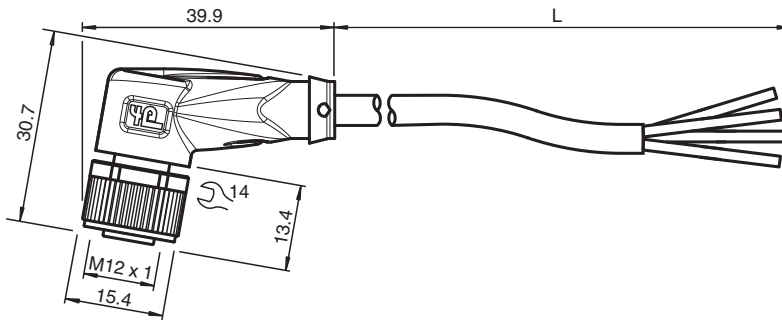

### Technical Data

#### General specifications

Connector 1	
Connection	socket
Construction type	M12
Style	angled
Locking	screw connection
Number of pins	4
Coding	A-coded
Connector 2	
Connection	cable end

#### Electrical specifications

Operating voltage	$U_B$	max. 250 V AC/DC
Operating current	$I_B$	max. 4 A

#### Conformity

Degree of protection	EN 60529
Plug connection	connector M12 x 1 : IEC 61076-2-101
Flammability	UL 1581; DIN EN 60332-2-2
PWIS conformity	VW-PV 3.10.7
Halogen-free	DIN VDE 0472-815

Release date: 2023-09-04 Date of issue: 2023-09-05 Filename: 70128170-100000\_eng.pdf

## Technical Data

Oil resistance		DIN EN 60811-2-1
<b>Approvals and certificates</b>		
UL approval		AWM STYLE 20549 AWM I/II A/B 80°C 300V FT2 (cable)
UL File Number		E231213
<b>Ambient conditions</b>		
Ambient temperature		
Plug connector		-40 ... 90 °C (-40 ... 194 °F)
Cable, fixed		-40 ... 80 °C (-40 ... 176 °F)
Cable, flexing		-25 ... 80 °C (-13 ... 176 °F)
Pollution degree		3
<b>Mechanical specifications</b>		
Plug connector		
Tightening torque		0.6 Nm
Loosening protection		available
Tool installation		straight knurling and hexagon nut SW = 14 mm
Mating cycles		min. 100
Degree of protection		IP68 / IP69
Cable		according to IEC/EN 60228 (DIN VDE 0295) class 6
Sheath diameter		4.9 mm
Bending radius		> 10 x cable diameter, moving > 5 x cable diameter, fixed
Sheath stripping force		max. 80 N / 300 mm
Sheath color		orange (similar to RAL 2003)
Number of cores		4
Core cross section		0.34 mm <sup>2</sup>
Cores color		Core 1: brown Core 2: white Core 3: blue Core 4: black
Core construction		42 x 0.1 mm Ø
Length	L	5 m
Cable code		Li F 9Y 11Y 4 x 0,34
<b>Drag chain suitability</b>		
Drag chain cycles		min. 5000000
Motion velocity		max. 3 m/s
Traverse distance		max. 5 m
Acceleration		max. 5 m/s <sup>2</sup>
Torsion cycles		min. 1000000
Torsional stress		± 180 °/m
<b>Material</b>		
PWIS free		yes
Halogen-free		yes
<b>Plug connector</b>		
Screw connection		Zinc diecast, nickel-plated
Body		TPU, black
Seal		FKM
Contact surface		gold plated (Au)
Flammability		V-2
<b>Cable</b>		
Sheathing		PUR based on polyether
Core insulation		PP
Welding-bead resistance		yes
Weld spatter resistance		yes
Chemical resistance		good

**Technical Data**





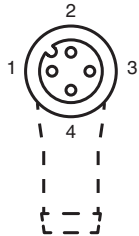

Oil resistance	yes
Cooling lubricant resistance	yes
Microbial resistance	yes
Hydrolysis resistance	yes
Flammability	FT2

**Connection**



- 1 ) ..... BN
- 2 ) ..... WH
- 3 ) ..... BU
- 4 ) ..... BK

**Accessories**

	<b>MH V1-SCREWDRIVER</b>	Torque screwdriver (0.6 Nm)
	<b>MH V1-BIT M12</b>	plug-in cap M12
	<b>V1/V3-LABELHOLDER</b>	Label holder
	<b>V1/V3-LABEL</b>	Label plate
	<b>MH V1-Holder</b>	Modular universal holder for M12 connectors
	<b>V1-CLIP</b>	Unlocking protector for M12 connector
	<b>V1-MARKING-RING-COLOR</b>	Marking rings for M12 connectors, various colors

Release date: 2023-09-04 Date of issue: 2023-09-05 Filename: 70128170-100000\_eng.pdf