

Drive-over profile rail PGV-PR-SM-CONT200

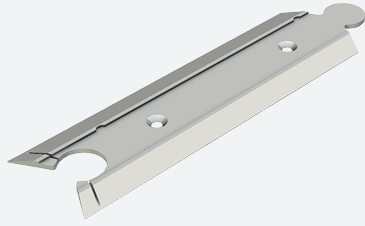

- Sturdy construction

Drive-over rail to realize endless tracks

Dimensions

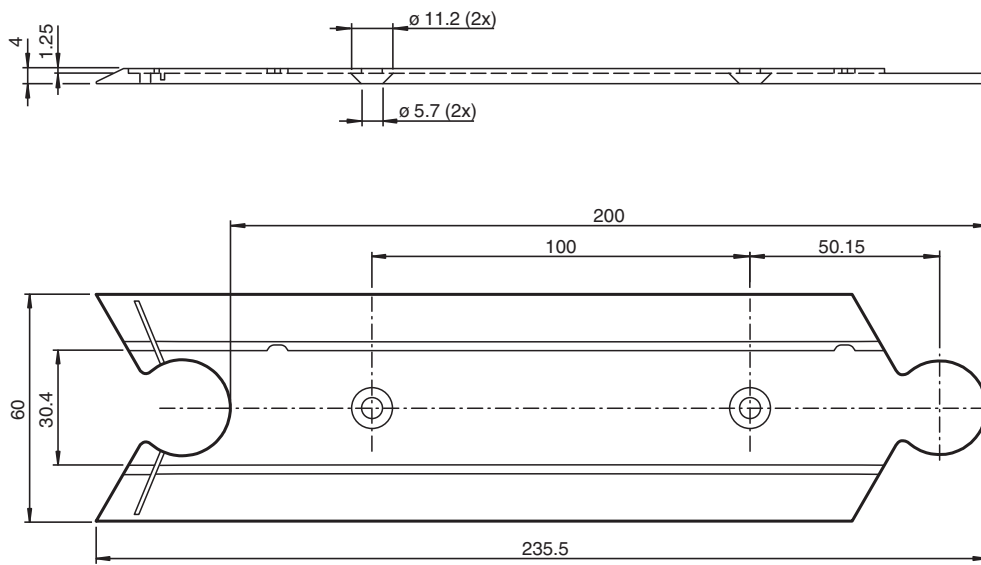

Technical Data

General specifications

Length	235.5 mm
Width	60 mm

Ambient conditions

Operating temperature	-40 ... 80 °C (-40 ... 176 °F)
Installation temperature	10 ... 40 °C (50 ... 104 °F)

Mechanical specifications

Material thickness	4 mm
Material	AlMg4.5Mn0.7
Surface	ELOX-E0EV1-15

Release date: 2022-07-04 Date of issue: 2022-07-04 Filename: 70132457_eng.pdf



Technical Data

Mass	83 g
------	------

Mounting

Drive-over profile rails are screwed directly to the floor. Alternatively, the drive-over profile rails can be glued to the subfloor. The corresponding metal code bar is then inserted into the drive-over profile rails via the self-adhesive rear side. If necessary, metal code bars that have been glued in can be replaced by levering them out.

Accessories

	PGV-PR-SM-END	Drive-over rail to end continuous tracks
	PGV-PR-SM-START	Drive-over rail for starting continuous tracks