

Laser triangulation sensor with background suppression



OBT30-R3F-E3-0,2M-V31-L

- Very flat design for direct mounting without mounting bracket
- DuraBeam Laser Sensors - durable and employable like an LED
- Small parts detection from 0.05 mm
- Highly visible light spot, even on dark materials
- Extremely small light spot for very high switching point accuracy
- Precision object detection, almost irrespective of the color

Triangulation sensor with background suppression



Dimensions

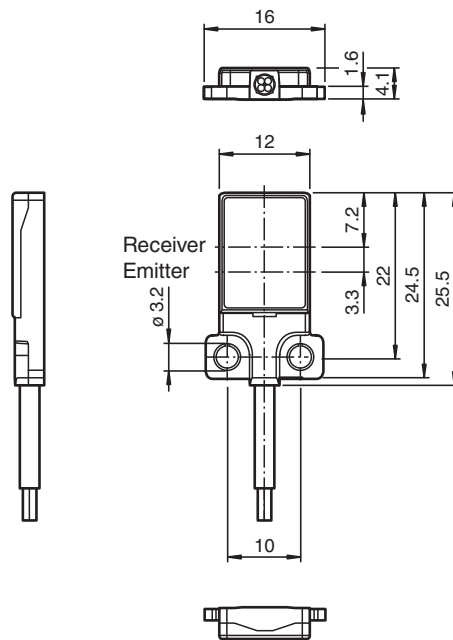

Technical Data

General specifications

Detection range	3 ... 30 mm
Reference target	standard white, 100 mm x 100 mm
Light source	LASER LIGHT
Light type	modulated visible red light , 680 nm
Laser nominal ratings	
Note	LASER LIGHT , DO NOT STARE INTO BEAM
Laser class	1
Wave length	680 nm
Beam divergence	> 5 mrad

Release date: 2023-04-25 Date of issue: 2023-04-25 Filename: 70133771_eng.pdf

Technical Data

Pulse length		approx. 3 μ s
Repetition rate		approx. 16.6 kHz
max. pulse energy		8 nJ
Black-white difference (6 %/90 %)		< 20 % at 30 mm
Angle deviation		approx. 0.5 °
Object size		typ. starts from 0.05 mm @ 20 mm
Diameter of the light spot		1.5 mm +/- 1 mm at a distance of 30 mm
Opening angle		approx. 1 °
Optical face		frontal
Ambient light limit		EN 60947-5-2 : 25000 Lux
Functional safety related parameters		
MTTF _d		800 a
Mission Time (T _M)		20 a
Diagnostic Coverage (DC)		0 %
Indicators/operating means		
Operation indicator		LED green, statically lit Power on , short-circuit : LED green flashing (approx. 4 Hz)
Function indicator		LED yellow ON: lights when object is detected
Electrical specifications		
Operating voltage	U _B	12 ... 24 V
No-load supply current	I ₀	< 10 mA
Protection class		III
Output		
Switching type		NC contact / dark-on
Signal output		1 PNP output, short-circuit protected, reverse polarity protected, open collector
Switching voltage		max. 30 V DC
Switching current		max. 50 mA
Voltage drop	U _d	≤ 1.5 V DC
Switching frequency	f	approx. 2 kHz
Response time		250 μ s
Conformity		
Product standard		EN 60947-5-2
Laser safety		EN 60825-1:2007
Approvals and certificates		
UL approval		E87056 , cULus Recognized, Class 2 Power Source
CCC approval		CCC approval / marking not required for products rated ≤36 V
FDA approval		IEC 60825-1:2007 Complies with 21 CFR 1040.10 and 1040.11 except for deviations pursuant to Laser Notice No. 50, dated June 24, 2007
Ambient conditions		
Ambient temperature		-10 ... 60 °C (14 ... 140 °F)
Storage temperature		-20 ... 70 °C (-4 ... 158 °F)
Mechanical specifications		
Housing width		16 mm
Housing height		25.5 mm
Housing depth		4.1 mm
Degree of protection		IP67
Connection		200 mm fixed cable with 4-pin, M8x1 connector
Material		
Housing		PC (Polycarbonate) and Stainless steel
Optical face		PMMA
Cable		PUR
Mass		approx. 10 g
Tightening torque, fastening screws		1 Nm
Cable length		200 mm

Connection

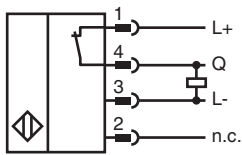

Connection Assignment



Wire colors in accordance with EN 60947-5-2

1	BN	(brown)
2	WH	(white)
3	BU	(blue)
4	BK	(black)

Characteristic Curve

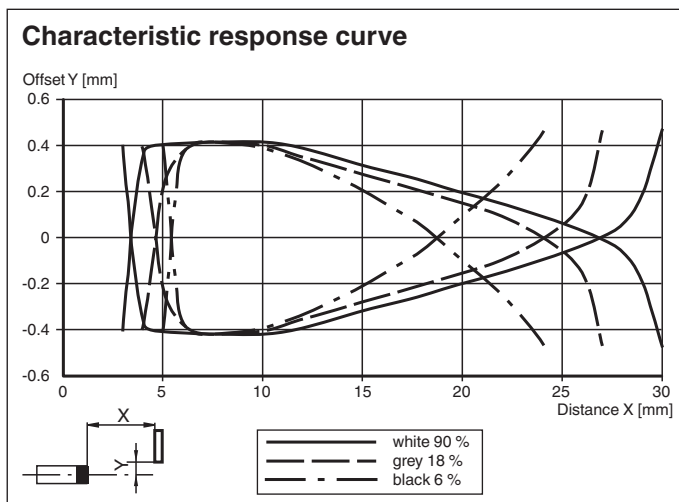

Characteristic Curve

Detection ranges

Object colour

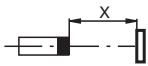
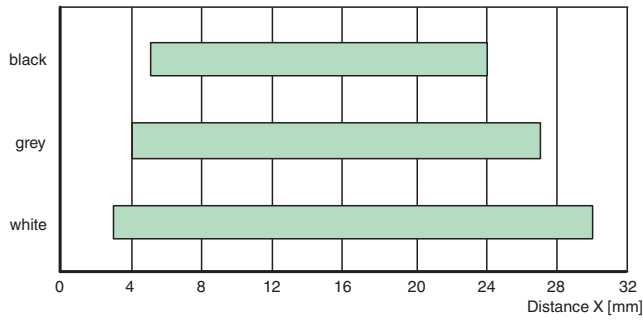

Light spot diameter

Diameter in mm

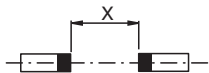
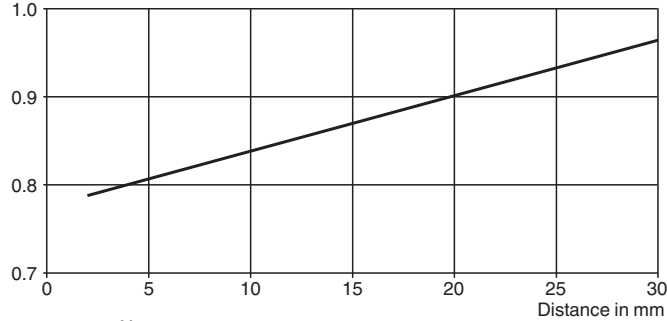

Safety Information

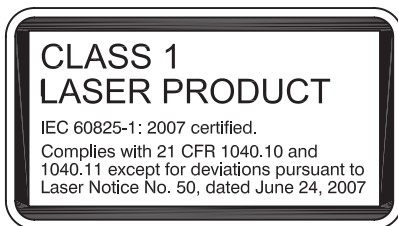

Release date: 2023-04-25 Date of issue: 2023-04-25 Filename: 70133771_eng.pdf

Safety Information

Laser Class 1 Information

The irradiation can lead to irritation especially in a dark environment. Do not point at people!



Maintenance and repairs should only be carried out by authorized service personnel!

Attach the device so that the warning is clearly visible and readable.

The warning accompanies the device and should be attached in immediate proximity to the device.

Caution – Use of controls or adjustments or performance of procedures other than those specified herein may result in hazardous radiation exposure.

Accessories

	V31-GM-2M-PUR	Female cordset single-ended M8 straight A-coded, 4-pin, PUR cable grey
	V31-WM-2M-PUR	Female cordset single-ended M8 angled A-coded, 4-pin, PUR cable grey