



Triangulation sensor (BGS)

OBT60-R3-E0-P



- Ultra-small housing design
- 45° cable outlet for maximum mounting freedom under extremely tight space constraints
- Highly visible light spot, even on dark materials
- Precision object detection, almost irrespective of the color
- Adjustable sensing range

Triangulation sensor with background suppression for standard applications, miniature design, 60 mm adjustable sensing range, red light, light on, NPN output, fixed cable



Function

The nano sensor has been developed for a broad range of applications. It offers excellent durability and is exceptionally easy to install. The housing is compact and, with its 45° cable outlet, can be installed in the smallest spaces. New functional principles and functionality open up a range of new options.

Dimensions

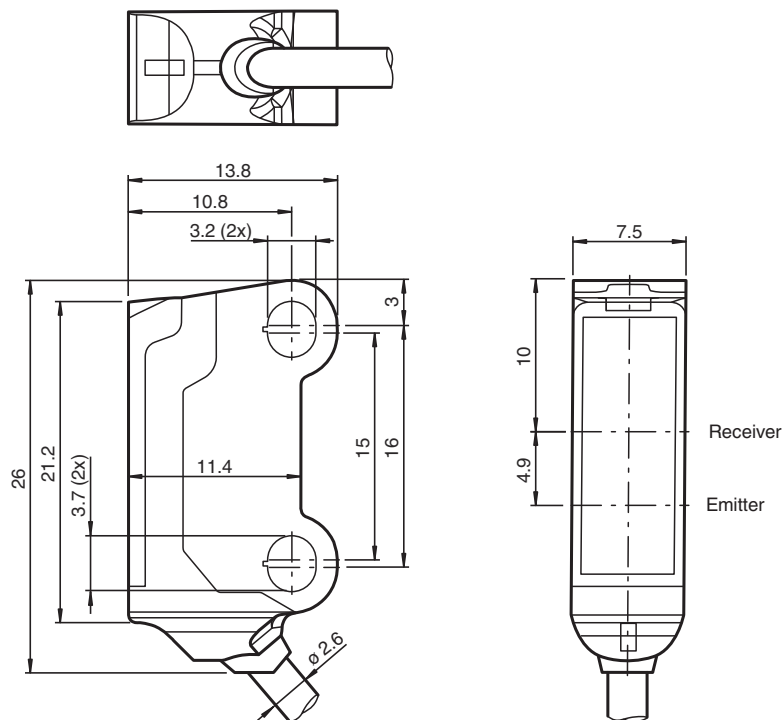

Technical Data

General specifications

Detection range	1 ... 60 mm
Detection range min.	1 ... 15 mm
Detection range max.	1 ... 60 mm
Adjustment range	15 ... 60 mm

Release date: 2024-08-06 Date of issue: 2024-08-06 Filename: 70134010_eng.pdf

Technical Data

Reference target	standard white, 100 mm x 100 mm	
Light source	LED	
Light type	modulated visible red light	
LED risk group labelling	exempt group	
Black-white difference (6 %/90 %)	< 5 % at 60 mm	
Diameter of the light spot	approx. 6 mm at a distance of 60 mm	
Opening angle	approx. 6 °	
Optical face	frontal	
Ambient light limit	EN 60947-5-2 : 5000 Lux	
Functional safety related parameters		
MTTF _d	764 a	
Mission Time (T _M)	20 a	
Diagnostic Coverage (DC)	0 %	
Indicators/operating means		
Operation indicator	LED green: Power on flashing (approx. 4 Hz) Short circuit/overload indication	
Function indicator	LED yellow ON: lights when object is detected Start teach in: LED green/yellow in-phase flashing 2.5 Hz End teach in: LED green/yellow alternate flashing 2.5 Hz	
Electrical specifications		
Operating voltage	U _B	12 ... 24 V DC , class 2
No-load supply current	I ₀	< 25 mA
Protection class	III	
Input		
Control input	external Teach-In	
Output		
Switching type	NPN normally open / light on	
Signal output	1 NPN output, short-circuit protected, reverse polarity protected, open collector	
Switching voltage	max. 24 V DC	
Switching current	max. 50 mA , resistive load	
Voltage drop	U _d	≤ 1.5 V DC
Switching frequency	f	approx. 500 Hz
Response time	1000 μs	
Conformity		
Product standard	EN 60947-5-2	
Approvals and certificates		
UL approval	E87056 , cURus Recognized Class 2 power source	
CCC approval	CCC approval / marking not required for products rated ≤36 V	
Ambient conditions		
Ambient temperature	-25 ... 55 °C (-13 ... 131 °F)	
Storage temperature	-30 ... 70 °C (-22 ... 158 °F)	
Mechanical specifications		
Degree of protection	IP67	
Connection	2 m fixed cable	
Material		
Housing	PC/ABS and TPU	
Optical face	Plastic	
Cable	PUR	
Mass	approx. 18 g	
Dimensions		
Height	26 mm	
Width	7.5 mm	
Depth	13.8 mm	
Cable length	2 m	

Connection

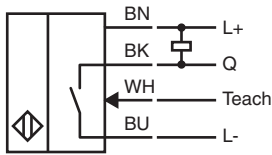

Indication

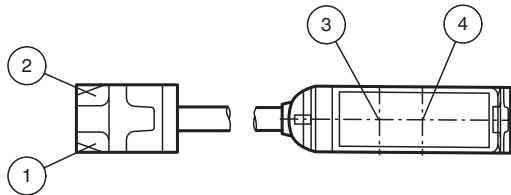

1	Operation indicator	green
2	Signal indicator	yellow
3	Emitter	
4	Receiver	

Characteristic Curve

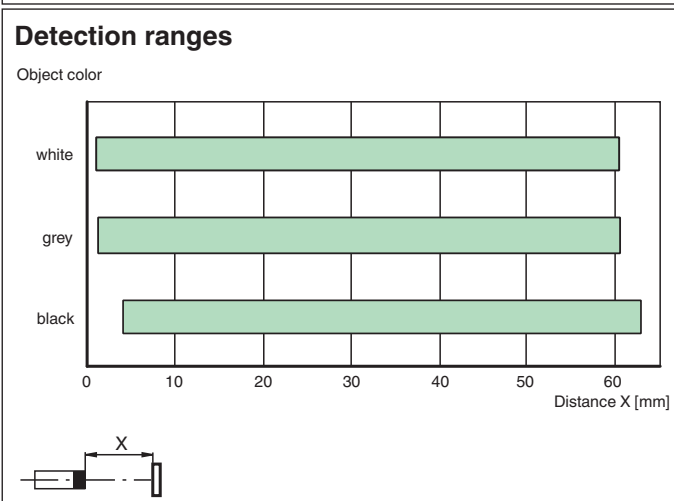
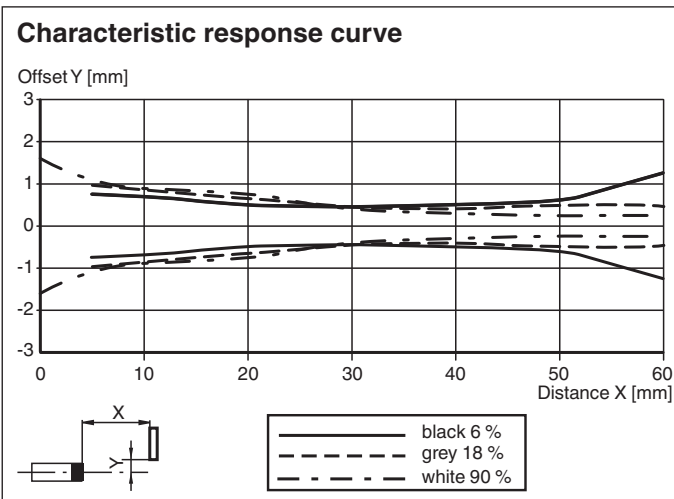

Release date: 2024-08-06 Date of issue: 2024-08-06 Filename: 70134010_eng.pdf

Characteristic Curve

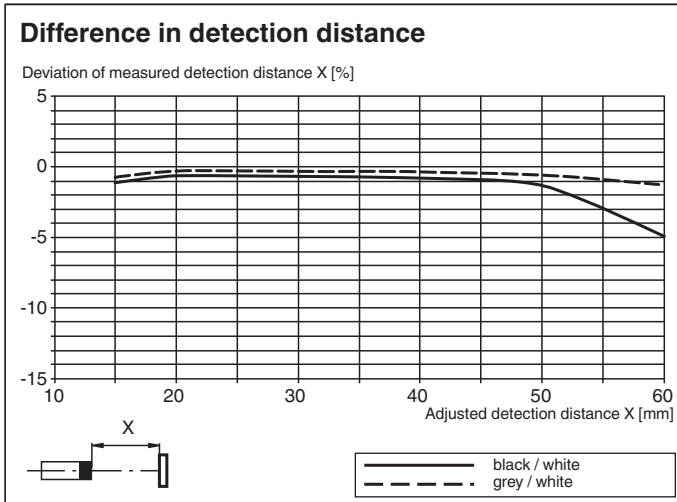

Release date: 2024-08-06 Date of issue: 2024-08-06 Filename: 70134010_eng.pdf