

Ultrasonic sensor

UC500-L2M-B16-V15-M

- CANopen interface
- E1-Type approval
- High EMC resistance
- Sensor head bidirectional and rotatable
- Rugged metal base
- Function indicators visible from all directions
- Degree of protection IP68

Single head system



Dimensions

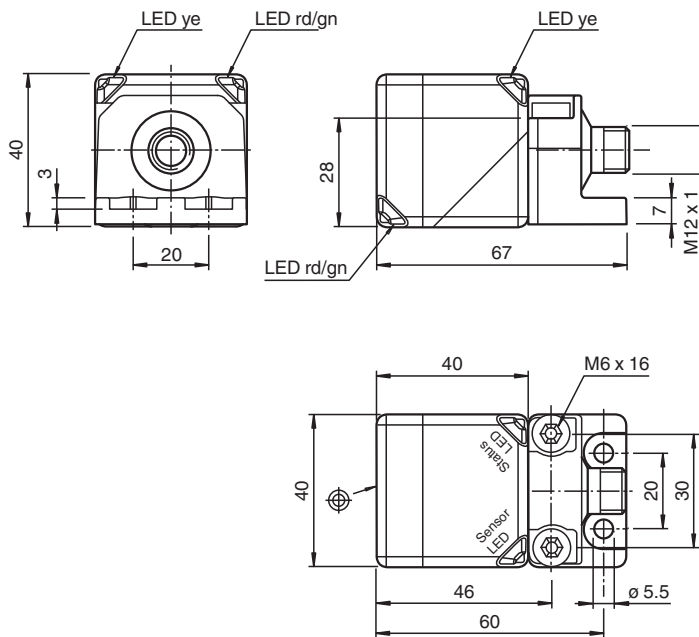

Technical Data

General specifications

Sensing range	30 ... 500 mm
Adjustment range	50 ... 500 mm
Dead band	0 ... 30 mm
Standard target plate	100 mm x 100 mm
Transducer frequency	approx. 380 kHz

Nominal ratings

Linearity error	< 5 mm
Temperature drift	< +/- 10 mm
Time delay before availability	t_v ≤ 700 ms

Release date: 2025-06-24 Date of issue: 2025-06-24 Filename: 70134319-100000_eng.pdf

Technical Data

Functional safety related parameters		
MTTF _d		421 a
Mission Time (T _M)		10 a
Diagnostic Coverage (DC)		0 %
Indicators/operating means		
LED yellow		object in evaluation range
LED red/green		CANopen status display
Electrical specifications		
Operating voltage	U _B	9 ... 30 V
No-load supply current	I ₀	≤ 50 mA
Power consumption	P ₀	typ. 0.6 W
Interface		
Interface type		CAN
Communication protocol		CANopen
Process data		Input: 48 Bit - measured value (distance value) 16 Bit - signal quality 8 Bit - counter-1 16 Bit or counter-2 8 Bit - status register 8 Bit
Node ID		programmable
Vendor ID		173 (0xAD)
Product code		50331649 (0x03000001)
Transfer rate		250 kBit/s , programmable 125 ... 1000 kBit/s
Termination		external
Cycle time		11.5 ms preset , programmable
Min. cycle time		11.5 ms
Compliance with standards and directives		
Standard conformity		
Standards		EN IEC 60947-5-2:2020 IEC 60947-5-2:2019
Communication interface		CiA 310, Ver. 4.2.0
Approvals and certificates		
UL approval		cULus Listed, Class 2 Power Source
CCC approval		CCC approval / marking not required for products rated ≤36 V
UN/ECE Regulation No. 10 (E1)		Type-approval number: 10R-069608
Ambient conditions		
Ambient temperature		-40 ... 85 °C (-40 ... 185 °F)
Storage temperature		-40 ... 85 °C (-40 ... 185 °F)
Mechanical specifications		
Connection type		Connector plug
Degree of protection		IP68
Material		
Housing		PA-GF35
Connector		
Threading		M12
Number of pins		5
Mass		170 g
Dimensions		
Height		40 mm
Width		40 mm
Length		67 mm
Factory settings		
Default setting		measured value "distance", signal quality, counter-2 (object 0x2000)
Beam width		wide (object 0x4000)

Technical Data

Synchronization	deactivated (object 0x2020)
Node ID	16
Transfer rate	250 kBit/s

Connection Assignment

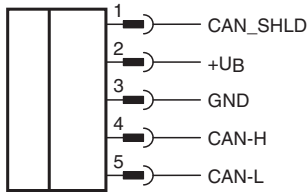

Connection Assignment

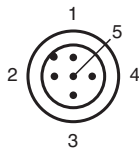

Characteristic Curve

Characteristic response curve

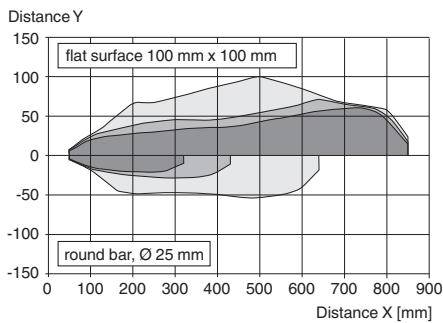

Release date: 2025-06-24 Date of issue: 2025-06-24 Filename: 70134319-100000_eng.pdf