

Cable socket, shielded

V15-W-BK5M-PUR-O2/CAN

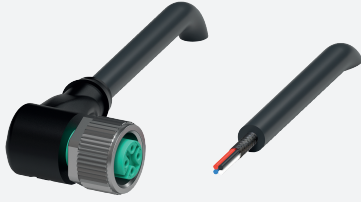

- Suitable for DeviceNet and CANopen
- Suitable for drag chains and abrasion resistant
- Degree of protection IP68 / IP69
- Resistant to microbes and hydrolysis
- UV resistant
- Resistant to salt water
- UL listed for USA and Canada
- Halogen-free
- Shield connected to pin 1
- Shield connected to screw connection
- Specific design protects against loosening and inaccurate installation

DeviceNet/CANOpen bus cable female cordset single-ended M12 angled A-coded 5-pin, PUR cable 4-core twisted pairs black, shielded, UL approved, drag chain suitable, outdoor



Dimensions

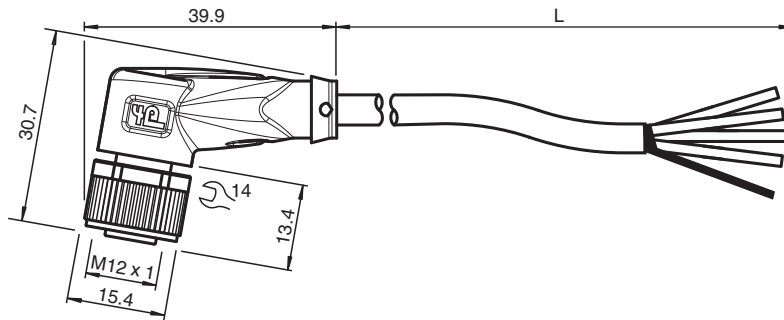

Technical Data

General specifications

Connector 1	
Connection	socket
Construction type	M12
Style	angled
Locking	screw connection
Number of pins	5
Coding	A-coded
Connector 2	
Connection	cable end

Electrical specifications

Operating voltage	U_B	max. 48 V AC / 60 V DC
Operating current	I_B	max. 4 A

Conformity

Degree of protection	EN 60529
Plug connection	connector M12 x 1 : IEC 61076-2-101
Flammability	UL 1581 , IEC 60332-1-2
Halogen-free	IEC 60754-1
Chemical resistance	DIN EN 60811-2-1

Release date: 2023-09-04 Date of issue: 2023-09-04 Filename: 70134459_eng.pdf

Technical Data

Microbial resistance		DIN EN 50525-2-21 / DIN VDE 0282-10
Hydrolysis resistance		DIN EN 50525-2-21
Oil resistance		DIN EN 60811-2-1
Approvals and certificates		
UL approval		AWM STYLE 21924/11558 105°C 300V AWM I A/B 105°C 300V FT2 (cable)
UL File Number		E231213
Ambient conditions		
Ambient temperature		
Plug connector		-40 ... 90 °C (-40 ... 194 °F)
Cable, fixed		-50 ... 105 °C (-58 ... 221 °F)
Cable, flexing		-30 ... 105 °C (-22 ... 221 °F)
Pollution degree		3
Mechanical specifications		
Plug connector		
Tightening torque		0.6 Nm
Loosening protection		available
Tool installation		straight knurling and hexagon nut SW = 14 mm
Mating cycles		min. 100
Shielding		shield connected to pin 1 and screw connection
Degree of protection		IP68 / IP69
Cable		according to IEC/EN 60228 (DIN VDE 0295) class 5
Sheath diameter		6 mm
Bending radius		> 10 x cable diameter, moving > 5 x cable diameter, single bend
Sheath stripping force		max. 80 N / 500 mm
Sheath color		black (similar to RAL 9005)
Number of cores		4
Core cross section		0.34 mm ²
Cores color		Core 2: red Core 3: black Core 4: white Core 5: blue
Core construction		19 x 0.15 mm Ø twisted pairs
Shield		tinned copper braiding, 85 % coverage
Length	L	5 m
Cable code		Li 9Y C11Y 2 x 2 x 0,34
Drag chain suitability		
Drag chain cycles		min. 3000000
Motion velocity		max. 2.5 m/s
Traverse distance		0.51 m
Acceleration		max. 12 m/s ²
Material		
PWIS free		yes
Halogen-free		yes
Plug connector		
Screw connection		Zinc diecast, nickel-plated
Body		TPU, black
Seal		FKM
Contact surface		gold plated (Au)
Flammability		V-2
Cable		
Sheathing		PUR based on polyether
Core insulation		PP
Salt water resistance		yes

Release date: 2023-09-04 Date of issue: 2023-09-04 Filename: 70134459_eng.pdf





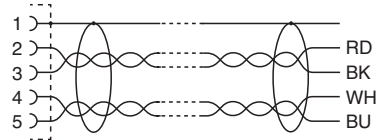
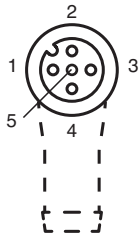

Technical Data

Oil resistance	yes
Microbial resistance	yes
Hydrolysis resistance	yes
Flammability	FT2

Connection



Accessories

	MH V1-SCREWDRIVER	Torque screwdriver (0.6 Nm)
	MH V1-BIT M12	plug-in cap M12
	V1/V3-LABELHOLDER	Label holder
	V1/V3-LABEL	Label plate
	MH V1-Holder	Modular universal holder for M12 connectors
	V1-CLIP	Unlocking protector for M12 connector
	V1-MARKING-RING-COLOR	Marking rings for M12 connectors, various colors