

## Thru-beam sensor (pair)

OBE10M-18GM60-SE4-V1-IR-1C



- Strong metallic housing in cylindrical shape M18 x 1
- Not sensitive to ambient light
- Degree of protection IP67
- Very high detection range

Thru-beam sensor (pair)



### Function

The optical sensors of this series have an M18 threaded housing that is optionally available in plastic or metal. The sensors are robust and versatile. Focusing on the essential requirements simplifies selection and commissioning, saving time and costs.

### Dimensions

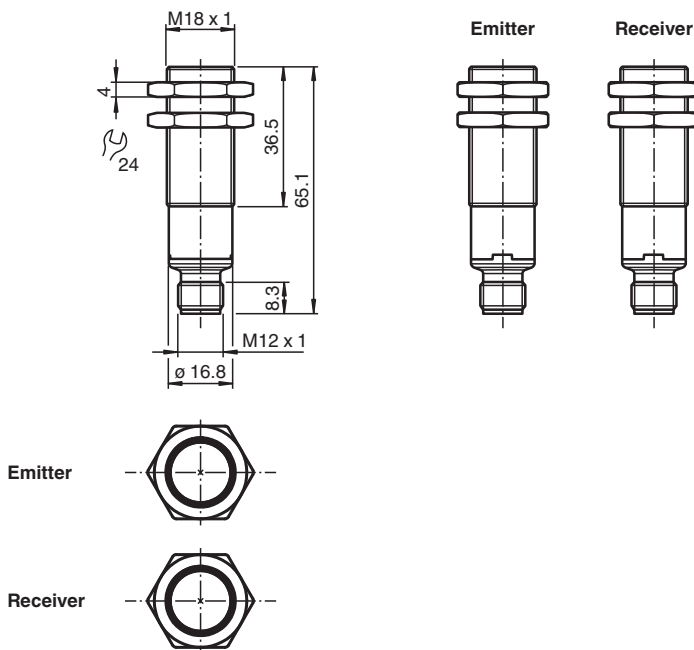

### Technical Data

#### System components

Emitter	OBE10M-18GM60-S-V1-IR-1C
Receiver	OBE10M-18GM60-E4-V1-IR-1C

#### General specifications

Effective detection range	0 ... 10 m
---------------------------	------------

Release date: 2021-12-16 Date of issue: 2021-12-16 Filename: 70134680\_eng.pdf

## Technical Data

Threshold detection range		17 m
Light source		IREd
Light type		Infrared LED
Diameter of the light spot		approx. 55 mm at 1 m
Angle of divergence		approx. 1.6 °
Optical face		frontal
Ambient light limit		EN 60947-5-2 10000 Lux
<b>Functional safety related parameters</b>		
MTTF <sub>d</sub>		564 a
Mission Time (T <sub>M</sub> )		20 a
Diagnostic Coverage (DC)		0 %
<b>Indicators/operating means</b>		
Operation indicator		LED green: on - power on flashing (4 Hz) - short circuit
Function indicator		Receiver: yellow LED permanently lit - output active permanently off - output inactive flashing (4 Hz) - insufficient operating reserve
Control elements		light/dark on electrically switchable
<b>Electrical specifications</b>		
Operating voltage	U <sub>B</sub>	10 ... 30 V DC
Ripple		max. 10 %
No-load supply current	I <sub>0</sub>	< 25 mA
Protection class		III
<b>Output</b>		
Switching type		The switching type of the sensor is adjustable. The default setting is: Q - Pin4: NPN output / light-on L/D-On - Pin2: Low-active input
Signal output		1 NPN output, short-circuit protected, reverse polarity protected, open collector
Switching voltage		max. 30 V DC
Switching current		max. 100 mA , resistive load
Voltage drop	U <sub>d</sub>	≤ 2 V DC
Switching frequency	f	500 Hz
Response time		≤ 1 ms
<b>Conformity</b>		
Product standard		EN 60947-5-2
<b>Approvals and certificates</b>		
UL approval		E87056 , cULus Listed , class 2 power supply , type rating 1
<b>Ambient conditions</b>		
Ambient temperature		-40 ... 60 °C (-40 ... 140 °F)
Storage temperature		-40 ... 70 °C (-40 ... 158 °F)
<b>Mechanical specifications</b>		
Degree of protection		IP67
Connection		4-pin, M12 x 1 connector
Material		
Housing		brass, nickel-plated
Optical face		PMMA
Connector		Plastic
Mass		approx. 23 g per device

### Connection

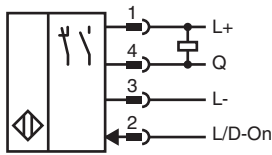

### Connection

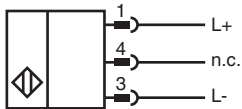

### Connection Assignment

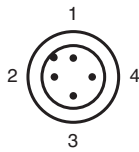

Wire colors in accordance with EN 60947-5-2

1	BN	(brown)
2	WH	(white)
3	BU	(blue)
4	BK	(black)

### Indication

#### Emitter

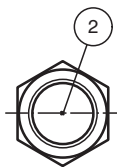
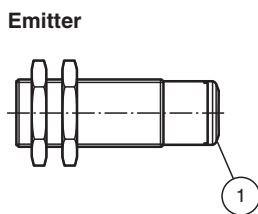

1	Operating display	green
2	Emitter	

#### Receiver

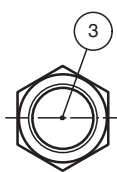
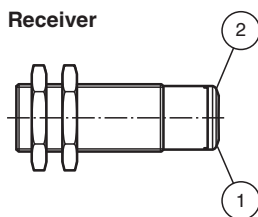



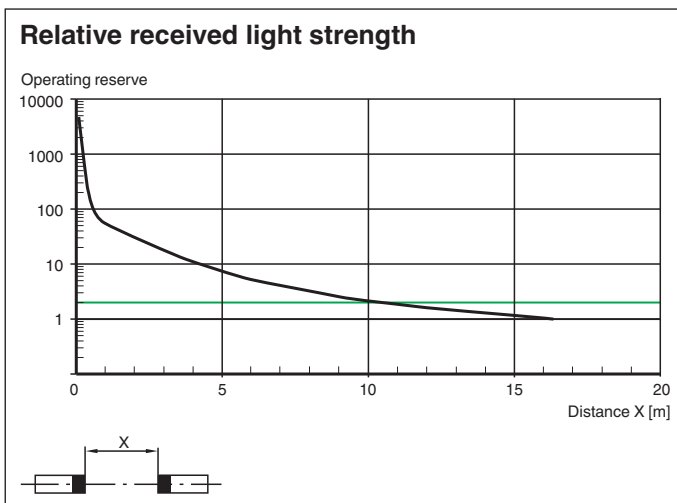
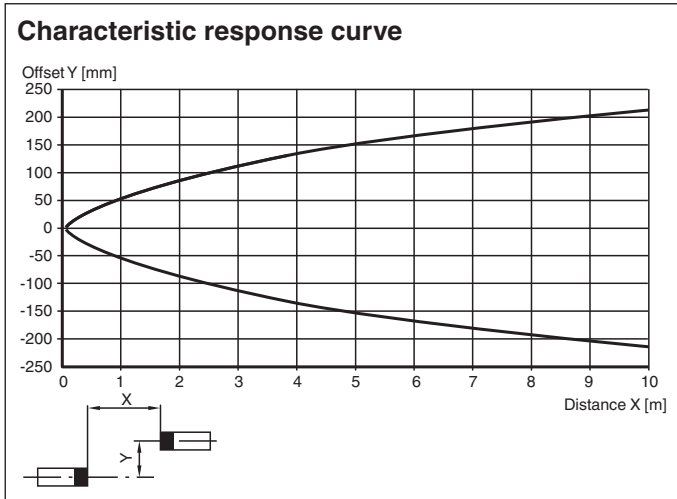

1	Operating display	green
2	Signal display	yellow
3	Receiver	

Release date: 2021-12-16 Date of issue: 2021-12-16 Filename: 70134680\_eng.pdf

## Characteristic Curve



## Accessories

	<b>BF 18</b>	Mounting flange, 18 mm
	<b>CPZ18B03</b>	Mounting Bracket with swivel nut
	<b>BF 18-F</b>	Plastic mounting adapter, 18 mm
	<b>BF 5-30</b>	Universal mounting bracket for cylindrical sensors with a diameter of 5 ... 30 mm