

WCS2 Code rail

WCS2-CS*-L1-S*****-L*****



- Flexible installation by means of alu profile- or mounting bracket system
- High chemical resistance
- Low weight

Code rail, polyester laminate

Dimensions

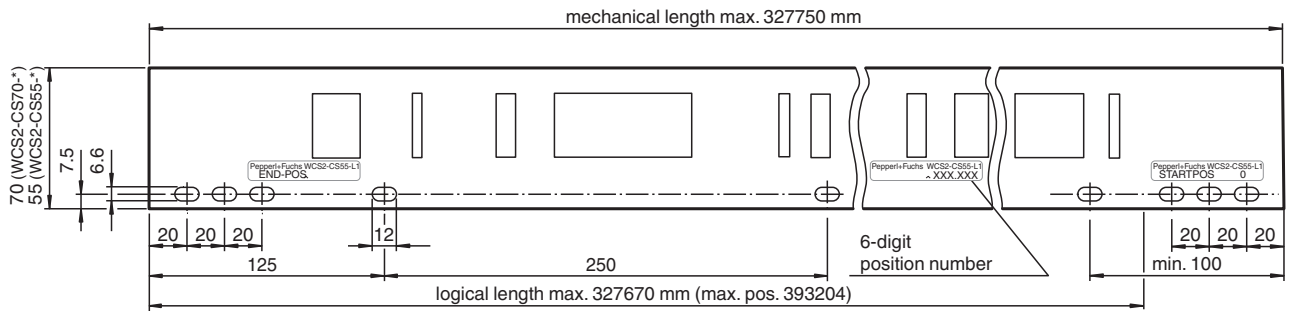

Technical Data

General specifications	
Code rail height	55 mm 70 mm
Total length	100 ... 327670 mm
Start position	0 ... 327570 mm
Radius of bend	≥ 500 mm
Ambient conditions	
Operating temperature	-40 ... 60 °C (-40 ... 140 °F)
Storage temperature	-40 ... 60 °C (-40 ... 140 °F)
Installation temperature	10 ... 60 °C (50 ... 140 °F)
Mechanical specifications	
Material thickness	0.75 ... 0.95 mm
Tension loading	≤ 230 N
Material	polyester laminate
Thermal expansion coefficient	approx. 2.8 x 10 ⁻⁵ / K
Mass	30 g / m
Manufacturing tolerance	± 1 mm/m

Release date: 2023-03-01 Date of issue: 2023-03-01 Filename: 70135037_eng.pdf

Mounting

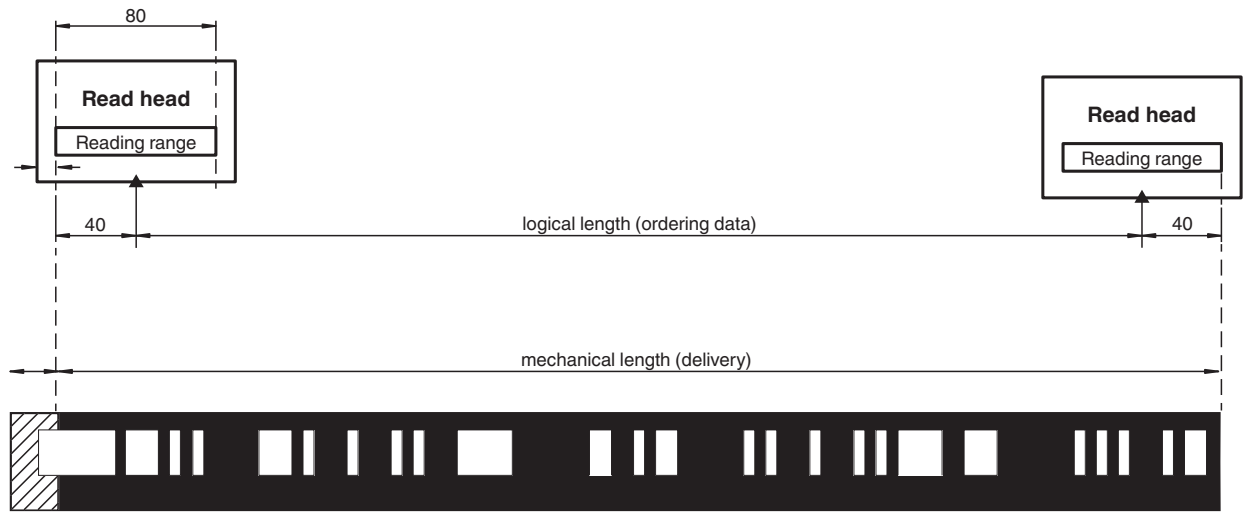

Automatic length correction:
Code rail is only delivered with
web ends or web beginnings



Type Code

Structure of the type code

W	C	S	2	-	C	S	(1)	-	L	1	-	S	(2)	(2)	(2)	(2)	(2)	(2)	-	L	(3)	(3)	(3)	(3)	(3)	(3)
---	---	---	---	---	---	---	-----	---	---	---	---	---	-----	-----	-----	-----	-----	-----	---	---	-----	-----	-----	-----	-----	-----





WCS2	Read head type
WCS	Position encoding system
CS	Code rail
C	Code
S	Rail
(1)	Code rail height
55	Code rail height
70	Code rail height
L	Code rail material
L	Polyester-Laminat
1	Mounting hole type
1	With mounting holes
S (2) (2) (2) (2) (2) (2)	Starting position
0 ... 327570	Starting position of the code rail in mm
L (3) (3) (3) (3) (3) (3)	Code rail length
100 ... 327670	Length of the code rail in mm

Accessories

	WCS2-FT1	Mounting tool to safely and quickly install the 55 mm code strip in the aluminum profile
	WCS2-GT09-P1	WCS2 guiding trolley

Release date: 2023-03-01 Date of issue: 2023-03-01 Filename: 70135037_eng.pdf

Accessories

	WCS2-LB1	WCS2 locking bracket
	WCS2-MC1	Butt connector, aluminum
	WCS2-MH1	Rail bracket with screwed connection
	WCS2-MH2	Rail bracket with screwed connection for C profile rails
	WCS2-PS1-2,5M	WCS2 profile rail