



WCS2 Code rail

WCS2-CS*-M1-S*****-L*****

- Flexible installation by means of alu profile- or mounting bracket system
- High mechanical stability
- Suitable for applications with wide temperature variations

Code rail, stainless steel

Dimensions

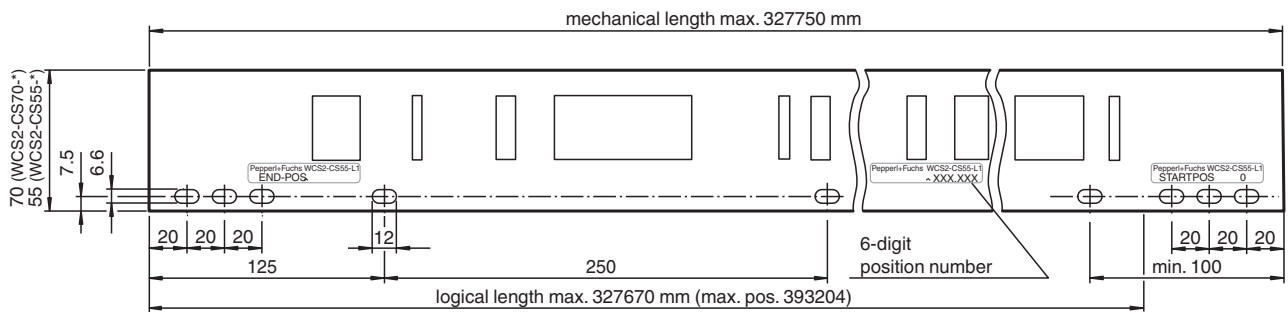

Technical Data

General specifications

Code rail height	55 mm 70 mm
Total length	100 ... 327670 mm
Start position	0 ... 327570 mm
Radius of bend	≥ 500 mm

Ambient conditions

Operating temperature	-40 ... 100 °C (-40 ... 212 °F)
Storage temperature	-40 ... 100 °C (-40 ... 212 °F)
Installation temperature	10 ... 60 °C (50 ... 140 °F)

Mechanical specifications

Material thickness	0.5 mm
Tension loading	≤ 4500 N
Material	stainless steel 1.4310 / AISI 301
Thermal expansion coefficient	1.6 x 10 ⁻⁵ / K
Mass	175 g / m
Manufacturing tolerance	± 1 mm/m

Release date: 2023-03-01 Date of issue: 2023-03-01 Filename: 70135876_eng.pdf

Mounting

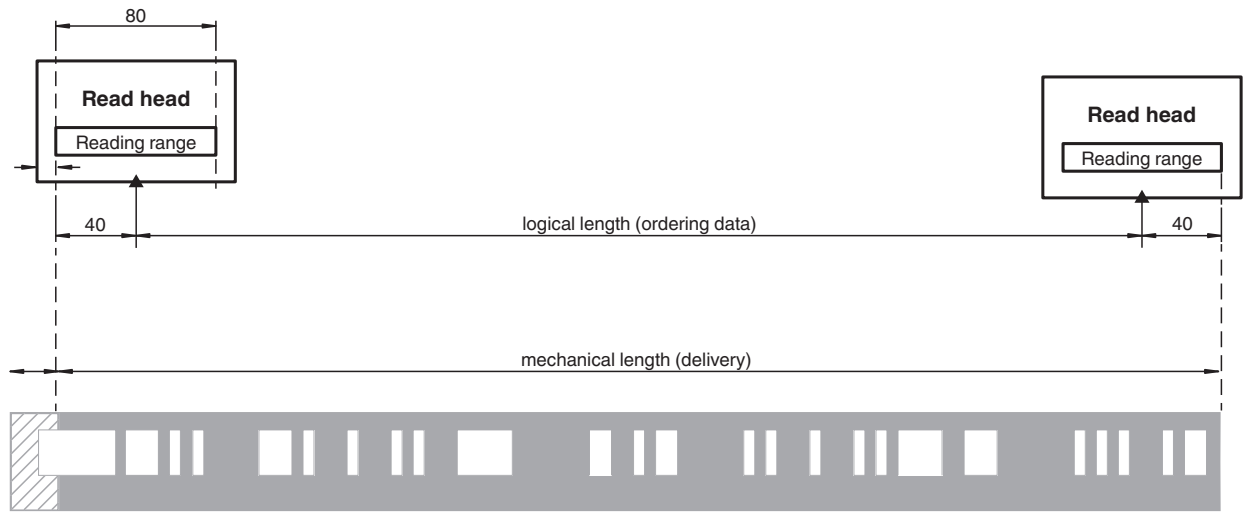

Automatic length correction:
Code rail is only delivered with
web ends or web beginnings

Type Code

Structure of the type code

W	C	S	2	-	C	S	(1)	-	M	1	-	S	(2)	(2)	(2)	(2)	(2)	(2)	-	L	(3)	(3)	(3)	(3)	(3)	(3)
---	---	---	---	---	---	---	-----	---	---	---	---	---	-----	-----	-----	-----	-----	-----	---	---	-----	-----	-----	-----	-----	-----

WCS2	Read head type
WCS	Position encoding system

CS	Code rail
C	Code
S	Rail

(1)	Code rail height
55	Code rail height
70	Code rail height



M	Code rail material
M	Stainless steel

1	Mounting hole type
1	With mounting holes

S (2) (2) (2) (2) (2) (2)	Starting position
0 ... 327570	Starting position of the code rail in mm









L (3) (3) (3) (3) (3) (3)	Code rail length
100 ... 327670	Length of the code rail in mm

Accessories

	WCS-MT1	Tensioning device for stainless steel code rail
	WCS-MF1	Wrist strap

Release date: 2023-03-01 Date of issue: 2023-03-01 Filename: 70135876_eng.pdf

Accessories

	WCS2-FT1	Mounting tool to safely and quickly install the 55 mm code strip in the aluminum profile
	WCS2-GT09-M1	WCS2 guiding trolley
	WCS2-LB1-C	WCS2 locking bracket
	WCS2-MC2	Butt connector, stainless steel
	WCS2-MH1	Rail bracket with screwed connection
	WCS2-MH2	Rail bracket with screwed connection for C profile rails
	WCS2-PS1-2,5M	WCS2 profile rail
	WCS2-PS1-C-2,5M	WCS2 profile rail, coated