

WCS3 code rail

WCS3-CS70-L1-S000000-L005000

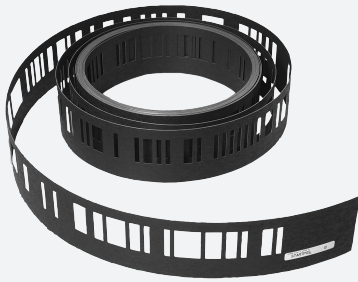

- Flexible installation by means of alu profile- or mounting bracket system
- High chemical resistance
- Low weight

Code rail, polyester laminate

Dimensions

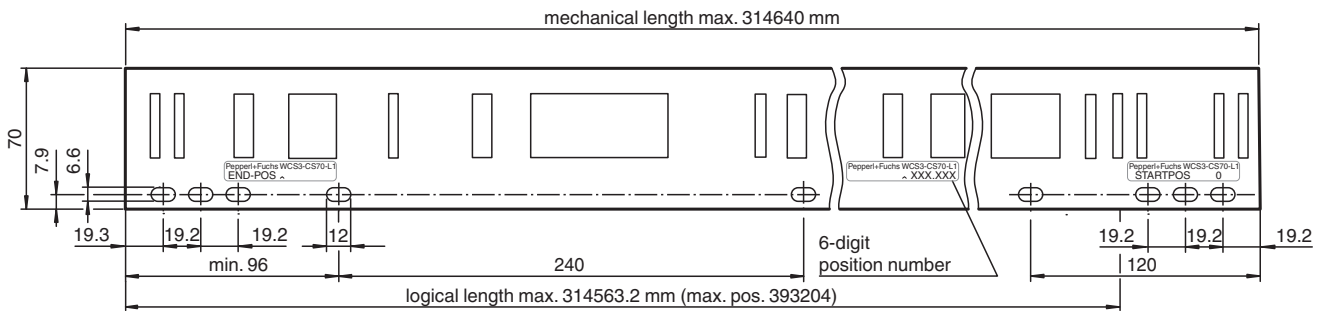

Technical Data

General specifications

Code rail height	70 mm
Total length	5000 mm
Start position	0 mm
Radius of bend	≥ 300 mm

Ambient conditions

Operating temperature	-40 ... 60 °C (-40 ... 140 °F)
Storage temperature	-40 ... 60 °C (-40 ... 140 °F)
Installation temperature	10 ... 60 °C (50 ... 140 °F)

Mechanical specifications

Material thickness	0.75 ... 0.95 mm
Tension loading	≤ 260 N
Material	polyester laminate
Thermal expansion coefficient	approx. 2.8×10^{-5} / K
Mass	40 g / m
Manufacturing tolerance	± 1 mm/m

Release date: 2024-08-23 Date of issue: 2024-08-23 Filename: 70135877-100010_eng.pdf

Mounting



Automatic length correction:
Code rail is only delivered with
web ends or web beginnings.

Type Code

Structure of the type code

W	C	S	3	-	C	S	70	-	L	(1)	-	S	(2)	(2)	(2)	(2)	(2)	(2)	-	L	(3)	(3)	(3)	(3)	(3)	(3)
---	---	---	---	---	---	---	----	---	---	-----	---	---	-----	-----	-----	-----	-----	-----	---	---	-----	-----	-----	-----	-----	-----

WCS3	Read head type
WCS	Position encoding system

CS	Code rail
C	Code
S	Rail

70	Code rail height
70	Code rail height

L	Code rail material
L	Polyester-Laminat

(1)	Mounting hole type
0	Without mounting holes
1	With mounting holes
2	With Vahle mounting holes

S (2) (2) (2) (2) (2)	Starting position
(2)	
0 ... 314463	Starting position of the code rail in mm

L (3) (3) (3) (3) (3)	Code rail length
100 ... 314563	Length of the code rail in mm

Release date: 2024-08-23 Date of issue: 2024-08-23 Filename: 70135877-100010_eng.pdf