

# WCS3 code rail

## WCS3-CS70-L1-S000000-L003000

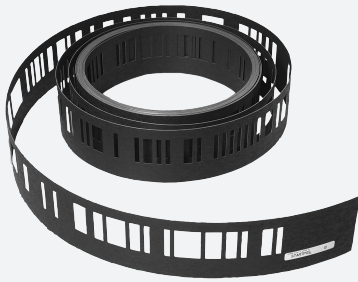

- Flexible installation by means of alu profile- or mounting bracket system
- High chemical resistance
- Low weight

Code rail, polyester laminate

### Dimensions

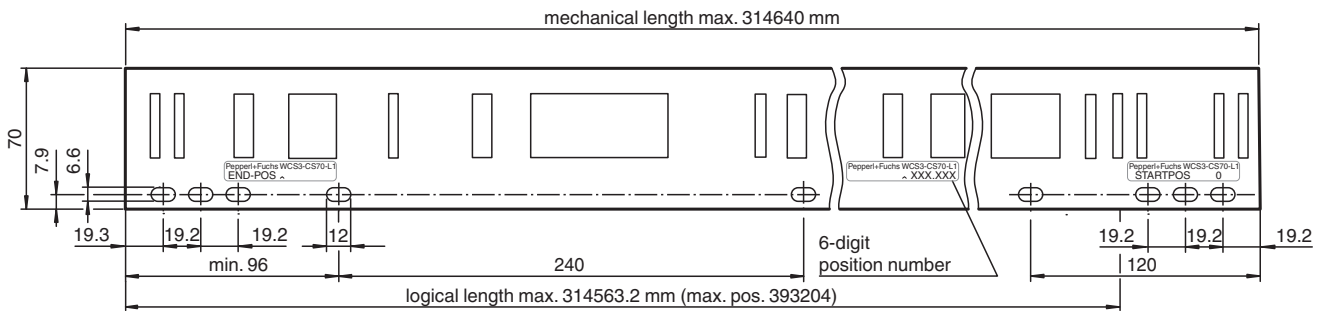

### Technical Data

#### General specifications

Code rail height	70 mm
Total length	3000 mm
Start position	0 mm
Radius of bend	≥ 300 mm

#### Ambient conditions

Operating temperature	-40 ... 60 °C (-40 ... 140 °F)
Storage temperature	-40 ... 60 °C (-40 ... 140 °F)
Installation temperature	10 ... 60 °C (50 ... 140 °F)

#### Mechanical specifications

Material thickness	0.75 ... 0.95 mm
Tension loading	≤ 260 N
Material	polyester laminate
Thermal expansion coefficient	approx. $2.8 \times 10^{-5}$ / K
Mass	40 g / m
Manufacturing tolerance	± 1 mm/m

Release date: 2024-08-23 Date of issue: 2024-08-23 Filename: 70135877-100016\_eng.pdf

## Mounting



Automatic length correction:  
Code rail is only delivered with  
web ends or web beginnings.

## Type Code

**Structure of the type code**

W	C	S	3	-	C	S	70	-	L	(1)	-	S	(2)	(2)	(2)	(2)	(2)	(2)	-	L	(3)	(3)	(3)	(3)	(3)	(3)
---	---	---	---	---	---	---	----	---	---	-----	---	---	-----	-----	-----	-----	-----	-----	---	---	-----	-----	-----	-----	-----	-----

<b>WCS3</b>	<b>Read head type</b>
WCS	Position encoding system
<b>CS</b>	<b>Code rail</b>
C	Code
S	Rail
<b>70</b>	<b>Code rail height</b>
70	Code rail height
<b>L</b>	<b>Code rail material</b>
L	Polyester-Laminat
<b>(1)</b>	<b>Mounting hole type</b>
0	Without mounting holes
1	With mounting holes
2	With Vahle mounting holes
<b>S (2) (2) (2) (2) (2)</b>	<b>Starting position</b>
(2)	
0 ... 314463	Starting position of the code rail in mm
<b>L (3) (3) (3) (3) (3)</b>	<b>Code rail length</b>
100 ... 314563	Length of the code rail in mm

Release date: 2024-08-23 Date of issue: 2024-08-23 Filename: 70135877-100016\_eng.pdf