



WCS3 code rail

WCS3-CS70-M1-S290000-L007000

- Flexible installation by means of alu profile- or mounting bracket system
- High mechanical stability
- Suitable for applications with wide temperature variations

Code rail, stainless steel

Dimensions

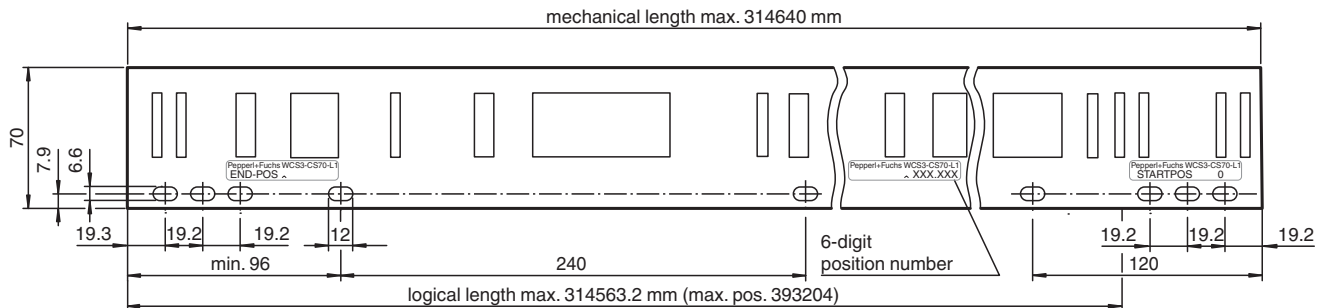

Technical Data

General specifications

Code rail height	70 mm
Total length	7000 mm
Start position	290000 mm
Radius of bend	≥ 300 mm

Ambient conditions

Operating temperature	-40 ... 100 °C (-40 ... 212 °F)
Storage temperature	-40 ... 100 °C (-40 ... 212 °F)
Installation temperature	10 ... 60 °C (50 ... 140 °F)

Mechanical specifications

Material thickness	0.5 mm
Tension loading	≤ 5000 N
Material	stainless steel 1.4310 / AISI 301
Thermal expansion coefficient	1.6 x 10 ⁻⁵ / K
Mass	240 g / m
Manufacturing tolerance	± 1 mm/m

Mounting



Automatic length correction:
Code rail is only delivered with
web ends or web beginnings

Type Code

Structure of the type code

W	C	S	3	-	C	S	70	-	M	1	-	S	(1)	(1)	(1)	(1)	(1)	(1)	-	L	(2)	(2)	(2)	(2)	(2)	(2)
---	---	---	---	---	---	---	----	---	---	---	---	---	-----	-----	-----	-----	-----	-----	---	---	-----	-----	-----	-----	-----	-----

WCS3	Read head type
WCS	Position encoding system

CS	Code rail
C	Code
S	Rail

70	Code rail height
70	Code rail height

M	Code rail material
M	Stainless steel

1	Mounting hole type
1	With mounting holes

S (1) (1) (1) (1) (1) (1)	Starting position
0 ... 314463	Starting position of the code rail in mm

L (2) (2) (2) (2) (2) (2)	Code rail length
100 ... 314563	Length of the code rail in mm

Release date: 2024-08-28 Date of issue: 2024-08-28 Filename: 70135878-100023_eng.pdf