



WCS3 code rail

WCS3-CS70-M1-S000000-L030500

- Flexible installation by means of alu profile- or mounting bracket system
- High mechanical stability
- Suitable for applications with wide temperature variations

Code rail, stainless steel

Dimensions

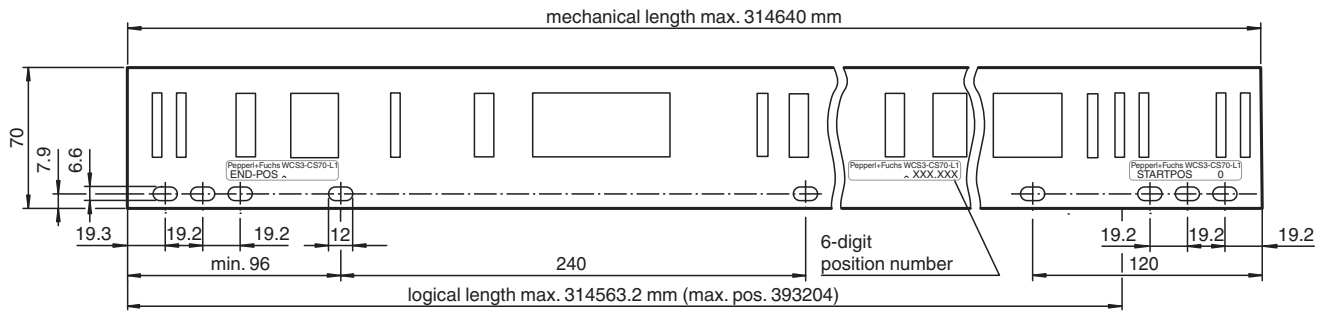

Technical Data

General specifications

Code rail height	70 mm
Total length	30500 mm
Start position	0 mm
Radius of bend	≥ 300 mm

Ambient conditions

Operating temperature	-40 ... 100 °C (-40 ... 212 °F)
Storage temperature	-40 ... 100 °C (-40 ... 212 °F)
Installation temperature	10 ... 60 °C (50 ... 140 °F)

Mechanical specifications

Material thickness	0.5 mm
Tension loading	≤ 5000 N
Material	stainless steel 1.4310 / AISI 301
Thermal expansion coefficient	1.6 x 10 ⁻⁵ / K
Mass	240 g / m
Manufacturing tolerance	± 1 mm/m

Mounting



Automatic length correction:
Code rail is only delivered with
web ends or web beginnings

Type Code

Structure of the type code

W	C	S	3	-	C	S	70	-	M	1	-	S	(1)	(1)	(1)	(1)	(1)	(1)	-	L	(2)	(2)	(2)	(2)	(2)	(2)
---	---	---	---	---	---	---	----	---	---	---	---	---	-----	-----	-----	-----	-----	-----	---	---	-----	-----	-----	-----	-----	-----

WCS3	Read head type
WCS	Position encoding system

CS	Code rail
C	Code
S	Rail

70	Code rail height
70	Code rail height

M	Code rail material
M	Stainless steel

1	Mounting hole type
1	With mounting holes

S (1) (1) (1) (1) (1) (1)	Starting position
0 ... 314463	Starting position of the code rail in mm

L (2) (2) (2) (2) (2) (2)	Code rail length
100 ... 314563	Length of the code rail in mm

Release date: 2024-08-28 Date of issue: 2024-08-28 Filename: 70135878-100036_eng.pdf