



## WCS3 code rail

WCS3-CS70-M1-S000000-L070000

- Flexible installation by means of alu profile- or mounting bracket system
- High mechanical stability
- Suitable for applications with wide temperature variations

Code rail, stainless steel

### Dimensions

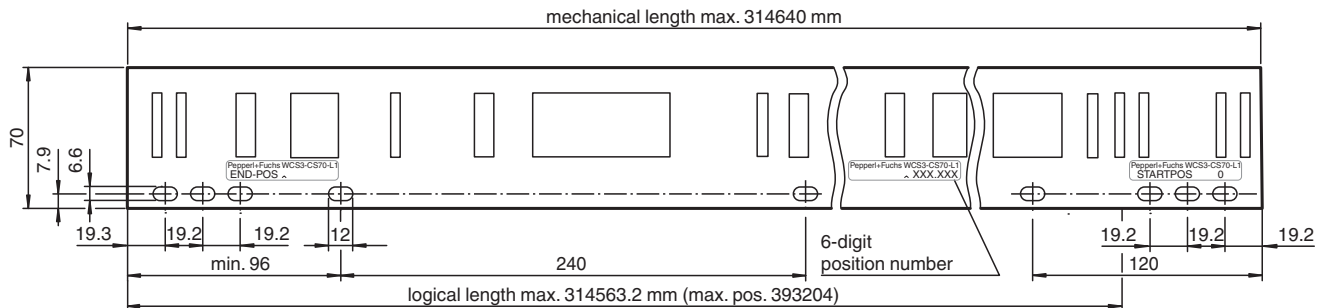

### Technical Data

#### General specifications

Code rail height	70 mm
Total length	70000 mm
Start position	0 mm
Radius of bend	≥ 300 mm

#### Ambient conditions

Operating temperature	-40 ... 100 °C (-40 ... 212 °F)
Storage temperature	-40 ... 100 °C (-40 ... 212 °F)
Installation temperature	10 ... 60 °C (50 ... 140 °F)

#### Mechanical specifications

Material thickness	0.5 mm
Tension loading	≤ 5000 N
Material	stainless steel 1.4310 / AISI 301
Thermal expansion coefficient	1.6 x 10 <sup>-5</sup> / K
Mass	240 g / m
Manufacturing tolerance	± 1 mm/m

## Mounting



Automatic length correction:  
Code rail is only delivered with  
web ends or web beginnings

## Type Code

### Structure of the type code

W	C	S	3	-	C	S	70	-	M	1	-	S	(1)	(1)	(1)	(1)	(1)	(1)	-	L	(2)	(2)	(2)	(2)	(2)	(2)
---	---	---	---	---	---	---	----	---	---	---	---	---	-----	-----	-----	-----	-----	-----	---	---	-----	-----	-----	-----	-----	-----

<b>WCS3</b>	<b>Read head type</b>
WCS	Position encoding system
<b>CS</b>	<b>Code rail</b>
C	Code
S	Rail
<b>70</b>	<b>Code rail height</b>
70	Code rail height
<b>M</b>	<b>Code rail material</b>
M	Stainless steel
<b>1</b>	<b>Mounting hole type</b>
1	With mounting holes
<b>S (1) (1) (1) (1) (1) (1)</b>	<b>Starting position</b>
0 ... 314463	Starting position of the code rail in mm
<b>L (2) (2) (2) (2) (2) (2)</b>	<b>Code rail length</b>
100 ... 314563	Length of the code rail in mm

Release date: 2024-08-28 Date of issue: 2024-08-28 Filename: 70135878-100042\_eng.pdf