

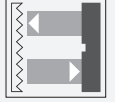

Retroreflective sensor ML17-54/33/115/136-10M



- Compact, versatile housing
- 360° high visibility LEDs
- Version with polarized filters detect shiny objects
- 4-in-1 output (push-pull)
- 10 m cable length

Retroreflective sensor with polarization filter



Function

The ML17 sensor family offers diverse connection and installation options, which means that it can adapt to the most varied automation tasks. In addition to the usual fitting method using M4 screws, these sensors can also be installed by means of M18 threaded insert. All devices are equipped with a green Power On display and a yellow function display. These displays are arranged in such a way that they are clearly visible from different directions.

Application

- Presence monitoring
- Target sensors
- Congestion monitoring
- Track loading
- Completeness checks

Dimensions

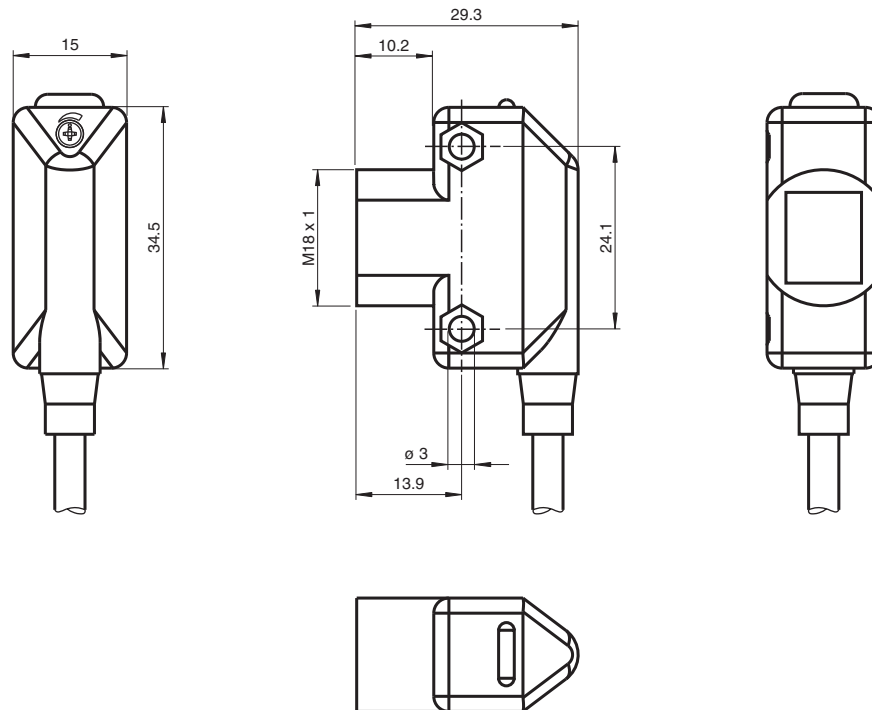

Technical Data

General specifications

Effective detection range	0 ... 3.5 m
Reflector distance	50 ... 3500 mm
Threshold detection range	5 m
Reference target	FE-RR1 reflector
Light source	LED
Light type	modulated visible red light , 626 nm
Polarization filter	yes
Ambient light limit	≤ 10000 Lux

Indicators/operating means

Operation indicator	LED green
Function indicator	LED yellow, lights up with receiver lit
Control elements	sensitivity adjustment

Electrical specifications

Operating voltage	U_B	10 ... 30 V DC , class 2
Ripple		max. 10 %
No-load supply current	I_0	< 25 mA
Operating current	I_B	100 mA max per output
Time delay before availability	t_v	≤ 200 ms

Output

Switching type	light/dark on
Signal output	2 push-pull (4 in 1) outputs, short-circuit protected, reverse polarity protected, overvoltage protected
Switching voltage	max. 30 V DC

Technical Data

Switching current		max. 100 mA
Voltage drop	U_d	≤ 2 V DC
Switching frequency	f	500 Hz
Response time		≤ 1 ms
Conformity		
Product standard		EN 60947-5-2
Approvals and certificates		
UL approval		cULus
CCC approval		CCC approval / marking not required for products rated ≤ 36 V
Ambient conditions		
Ambient temperature		-20 ... 55 °C (-4 ... 131 °F)
Storage temperature		-20 ... 70 °C (-4 ... 158 °F)
Mechanical specifications		
Housing width		15 mm
Housing height		34.5 mm
Degree of protection		IP67
Connection		10 m fixed cable
Material		
Housing		ABS
Optical face		Acrylic
Mass		approx. 190 g

Connection

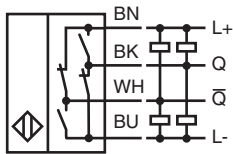

Assembly

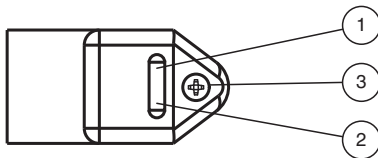

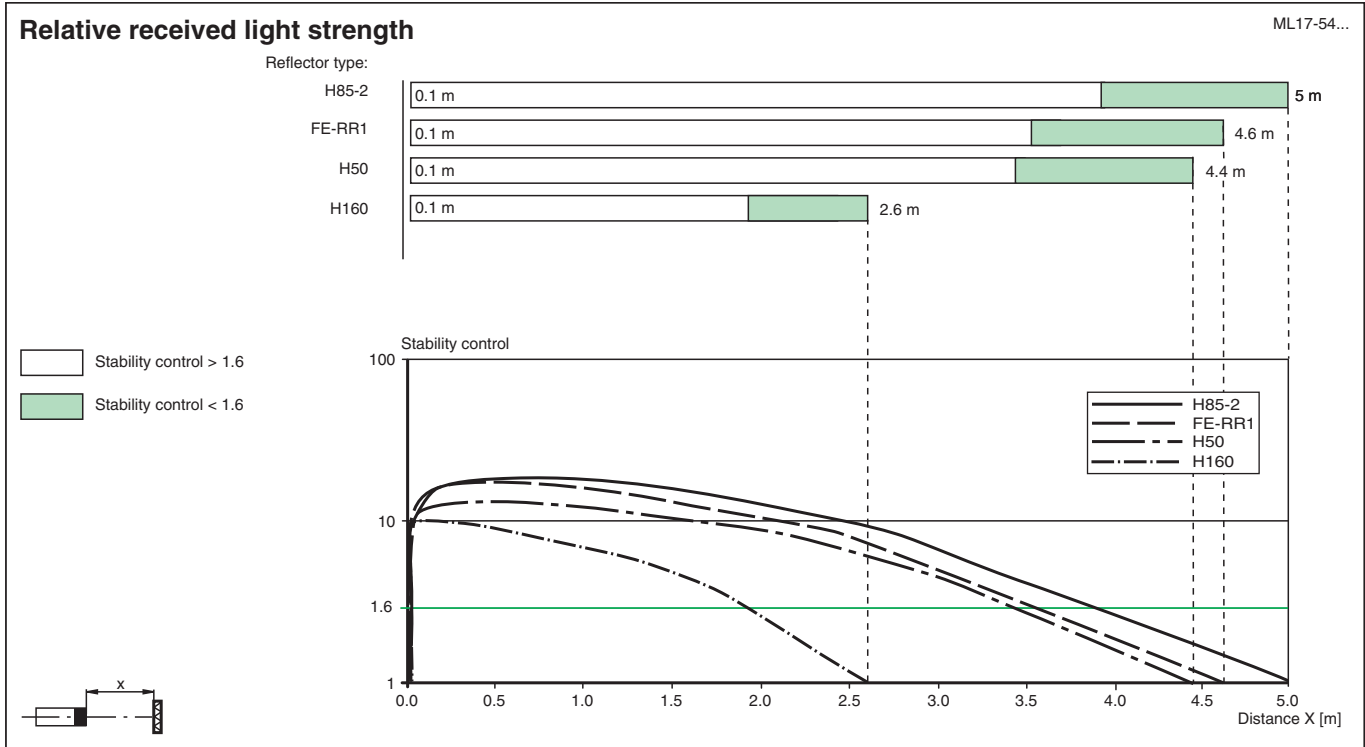
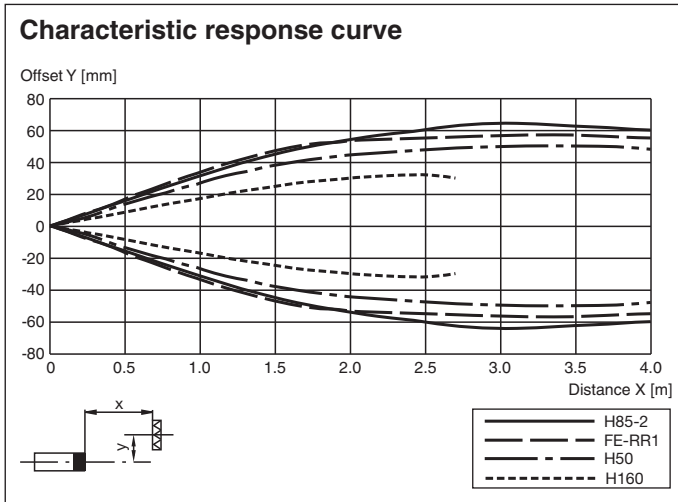

1	Signal display	yellow
2	Operating display	green
3	Sensitivity adjustment	

Characteristic Curve



Accessories

	OMH-ML17	Mounting bracket
	OMH-ML17-1	Mounting bracket

Release date: 2023-03-28 Date of issue: 2023-03-28 Filename: 70136758_eng.pdf