

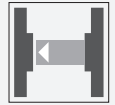

## Thru-beam sensor (pair)

### OBE1000-R2-SE3-P-L



- Ultra-small housing design
- DuraBeam Laser Sensors - durable and employable like an LED
- 45° cable outlet for maximum mounting freedom under extremely tight space constraints

Laser thru-beam sensor, ultra-small design with M2 mounting, 1000 mm detection range, light on, PNP output, 2 m fixed cable



### Function

The R2 series nano sensor has been developed for a broad range of applications. It offers excellent durability and is exceptionally easy to install. The housing is compact and, with its 45° cable outlet, can be installed in the smallest spaces. New functional principles and functionality open up a range of new options. The DuraBeam laser sensors are durable and can be used in the same way as a standard sensor.

### Dimensions

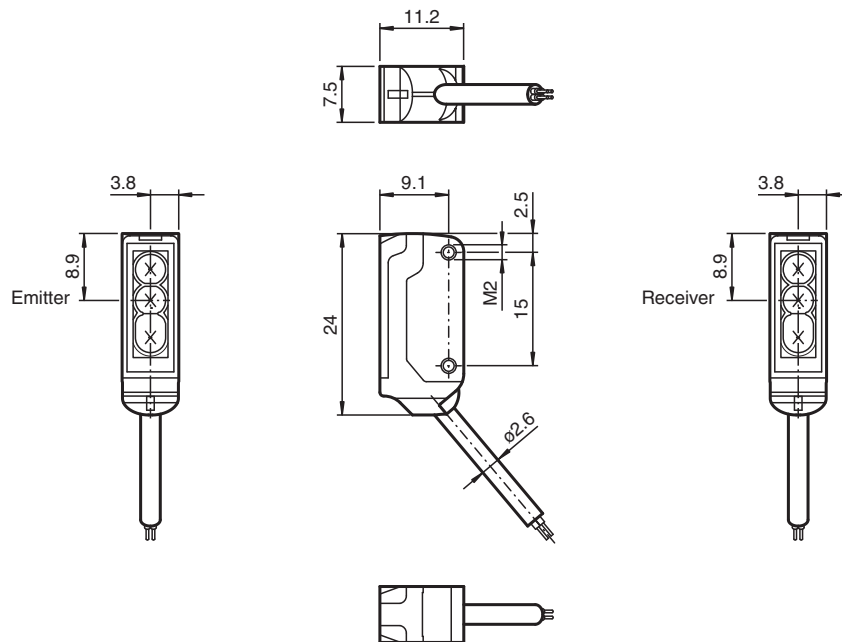

### Technical Data

#### System components

Emitter	OBE10M-R2-S-P-L
Receiver	OBE1000-R2-E3-P-L

#### General specifications

Effective detection range	0 ... 1 m
---------------------------	-----------

Release date: 2023-04-05 Date of issue: 2023-04-05 Filename: 70141725\_eng.pdf

## Technical Data

Threshold detection range		1.5 m
Light source		laser diode
Light type		modulated visible red light , 680 nm
Laser nominal ratings		
Note		LASER LIGHT , DO NOT STARE INTO BEAM
Laser class		1
Wave length		680 nm
Beam divergence		> 5 mrad
Pulse length		approx. 2 $\mu$ s
Repetition rate		approx. 16.6 kHz
max. pulse energy		9.5 nJ
Diameter of the light spot		approx. 3 mm at a distance of 1000 mm
Opening angle		approx. 0.5 °
Optical face		frontal
Ambient light limit		EN 60947-5-2 : 30000 Lux
<b>Functional safety related parameters</b>		
MTTF <sub>d</sub>		806 a
Mission Time (T <sub>M</sub> )		20 a
Diagnostic Coverage (DC)		0 %
<b>Indicators/operating means</b>		
Operation indicator		LED green, statically lit Power on , short-circuit : LED green flashing (approx. 4 Hz)
Function indicator		Receiver: LED yellow, lights up when light beam is free, flashes when falling short of the operating reserve ; OFF when light beam is interrupted
<b>Electrical specifications</b>		
Operating voltage	U <sub>B</sub>	12 ... 24 V
No-load supply current	I <sub>0</sub>	Emitter: $\leq$ 10 mA Receiver: $\leq$ 8 mA
Protection class		III
<b>Input</b>		
Test input		Test of switching function at 0 V
Switching threshold		Teach-In input
<b>Output</b>		
Switching type		NC contact / light on
Signal output		1 PNP output, short-circuit protected, reverse polarity protected, open collector
Switching voltage		max. 30 V DC
Switching current		max. 50 mA , resistive load
Voltage drop	U <sub>d</sub>	$\leq$ 1.5 V DC
Switching frequency	f	approx. 2 kHz
Response time		250 $\mu$ s
<b>Conformity</b>		
Product standard		EN 60947-5-2
Laser safety		EN 60825-1:2007
<b>Approvals and certificates</b>		
UL approval		E87056 , cULus Recognized, Class 2 Power Source
CCC approval		CCC approval / marking not required for products rated $\leq$ 36 V
FDA approval		IEC 60825-1:2007 Complies with 21 CFR 1040.10 and 1040.11 except for deviations pursuant to Laser Notice No. 50, dated June 24, 2007
<b>Ambient conditions</b>		
Ambient temperature		-20 ... 60 °C (-4 ... 140 °F)
Storage temperature		-30 ... 70 °C (-22 ... 158 °F)
<b>Mechanical specifications</b>		
Housing width		7.5 mm
Housing height		24 mm
Housing depth		11.2 mm

### Technical Data

Degree of protection	IP67
Connection	2 m fixed cable
Material	
Housing	PC/ABS and TPU
Optical face	PC
Cable	PUR
Installation	Fixing screws , 2 x M2 allen head screws included with delivery
Mass	approx. 20 g per sensor
Cable length	2 m

### Connection

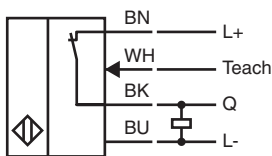
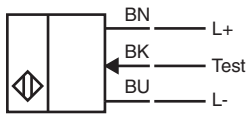

### Assembly

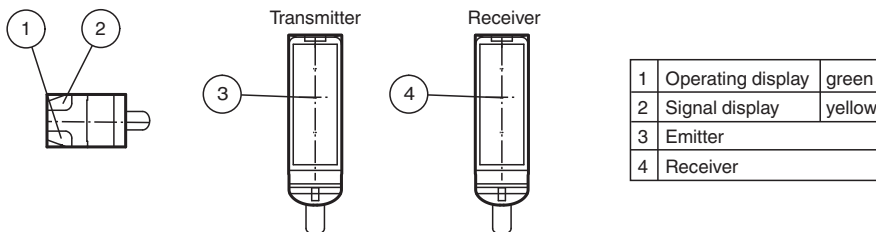

### Characteristic Curve

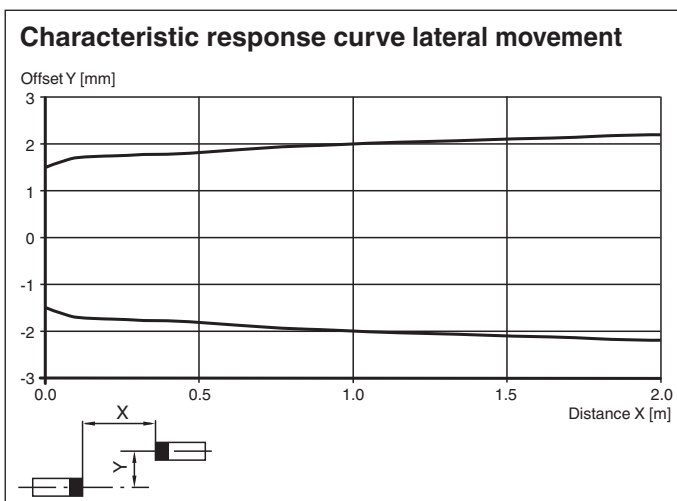

Release date: 2023-04-05 Date of issue: 2023-04-05 Filename: 70141725\_eng.pdf

## Characteristic Curve

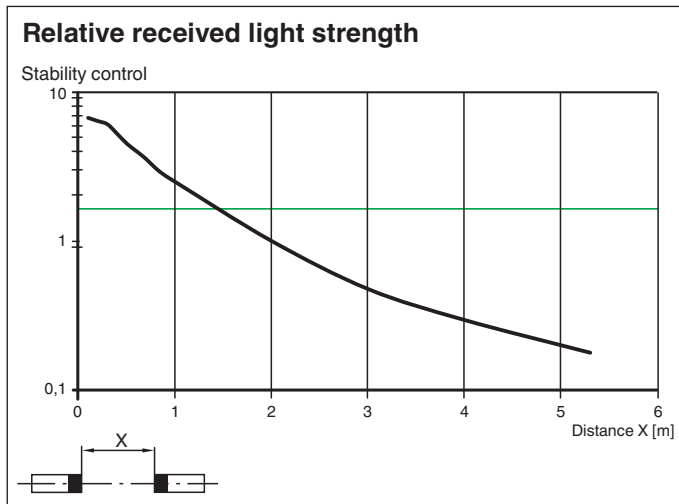

## Safety Information

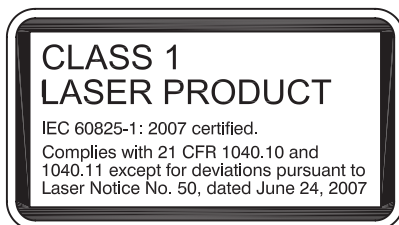



## Safety Information



### Laser Class 1 Information

The irradiation can lead to irritation especially in a dark environment. Do not point at people!  
 Maintenance and repairs should only be carried out by authorized service personnel!  
 Attach the device so that the warning is clearly visible and readable.  
 The warning accompanies the device and should be attached in immediate proximity to the device.  
 Caution – Use of controls or adjustments or performance of procedures other than those specified herein may result in hazardous radiation exposure.

## Accessories

	<b>MH-R2-01</b>	Mounting aid for R2 series, Mounting bracket
	<b>MH-R2-02</b>	Mounting aid for R2 series, Mounting bracket

**Accessories**

	<b>MH-R2-03</b>	Mounting aid for R2 series, Mounting bracket
	<b>MH-R2-04</b>	Mounting aid for R2 series, Mounting bracket

**Teach-In**

The thru-beam sensor enables the switching points to be taught in for optimum adaptation to specific applications. This eliminates the need for additional components such as apertures.

The sensitivity of the thru-beam sensor can be adjusted using three Teach-in methods:

**Position Teach**

When using this Teach-in method, the following settings are made on the thru-beam sensor:

- The gain is set to an optimum value
- The signal threshold is set to a minimum

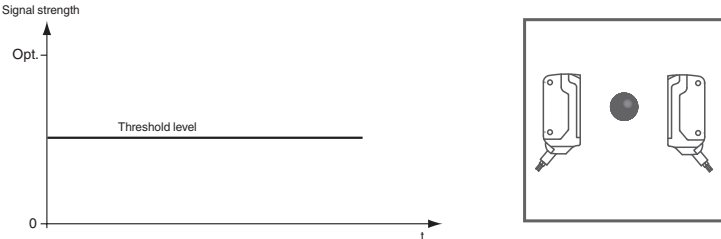

Recommended application:

This method enables minuscule particles in the beam path to be detected, and provides exceptional positioning accuracy. Make sure that there are no objects in the beam path and that the sensor is connected to the power supply.

1. Connect the white cable on the receiver (WH/IN) to the blue cable (BU/0 V) on the receiver.  
The green and yellow LED indicators flash simultaneously at 2.5 Hz
2. Disconnect the white cable on the receiver (WH/IN) from the blue cable (BU/0 V) on the receiver.  
The green and yellow LED indicators flash alternately at 2.5 Hz
3. The end of the Teach-in process is indicated when the green LED indicator lights up static and yellow LED blinks.

**Two-Point Teach-In**

When using this Teach-in method, the following settings are made on the thru-beam sensor:

- The gain is set to an optimum value
- The signal threshold is set in the center between the two taught signal values

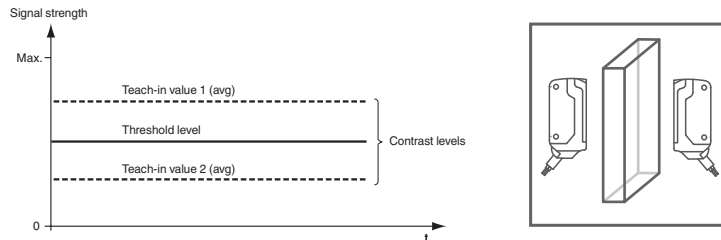

1. Make sure that there are no objects in the beam path and that the sensor is connected to the power supply.
2. Connect the white cable on the receiver (WH/IN) to the blue cable (BU/0 V) on the receiver.  
The green and yellow LED indicators flash simultaneously at 2.5 Hz
3. Position the object in the beam path.
4. Disconnect the white cable on the receiver (WH/IN) from the blue cable (BU/0 V) on the receiver.  
The green and yellow LED indicators flash alternately at 2.5 Hz
5. The end of the Teach-in process is indicated when the green LED indicator lights up static.

**Maximum Teach-In**

When using this Teach-in method, the following settings are made on the thru-beam sensor:

- The gain is set to a maximum
- The signal threshold is set to a minimum

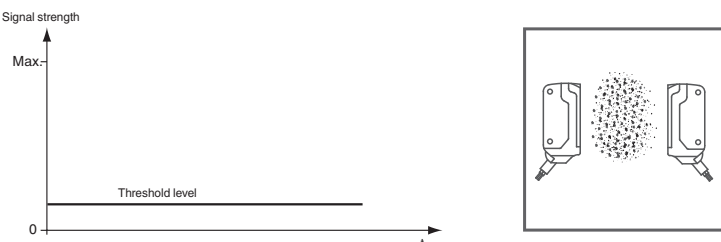

Recommended application:

Enables an object to be detected with a high excess gain. This can be useful if there is severe environmental contamination or to achieve long operating times.

Make sure that there are no objects in the beam path and that the sensor is connected to the power supply.

6. Cover the receiver or transmitter.
7. Connect the white cable on the receiver (WH/IN) to the blue cable (BU/0 V) on the receiver.

Release date: 2023-04-05 Date of issue: 2023-04-05 Filename: 70141725\_eng.pdf

## Thru-beam sensor (pair)

OBE1000-R2-SE3-P-L

The green and yellow LED indicators flash simultaneously at 2.5 Hz

8. Disconnect the white cable on the receiver (WH/IN) from the blue cable (BU/0 V) on the receiver.  
The green and yellow LED indicators flash alternately at 2.5 Hz
9. The end of the Teach-in process is indicated when the green LED indicator lights up static.