



Thru-beam sensor (pair)

OBE10M-R3-SE1-P-L



- Ultra-small housing design
- DuraBeam Laser Sensors - durable and employable like an LED
- 45° cable outlet for maximum mounting freedom under extremely tight space constraints

Laser thru-beam sensor, ultra-small design with M3 mounting, 10 m detection range, light on, NPN output, 2 m fixed cable



Function

The R3 series nano sensor has been developed for a broad range of applications. It offers excellent durability and is exceptionally easy to install. The housing is compact and, with its 45° cable outlet, can be installed in the smallest spaces. New functional principles and functionality open up a range of new options. The DuraBeam laser sensors are durable and can be used in the same way as a standard sensor.

Dimensions

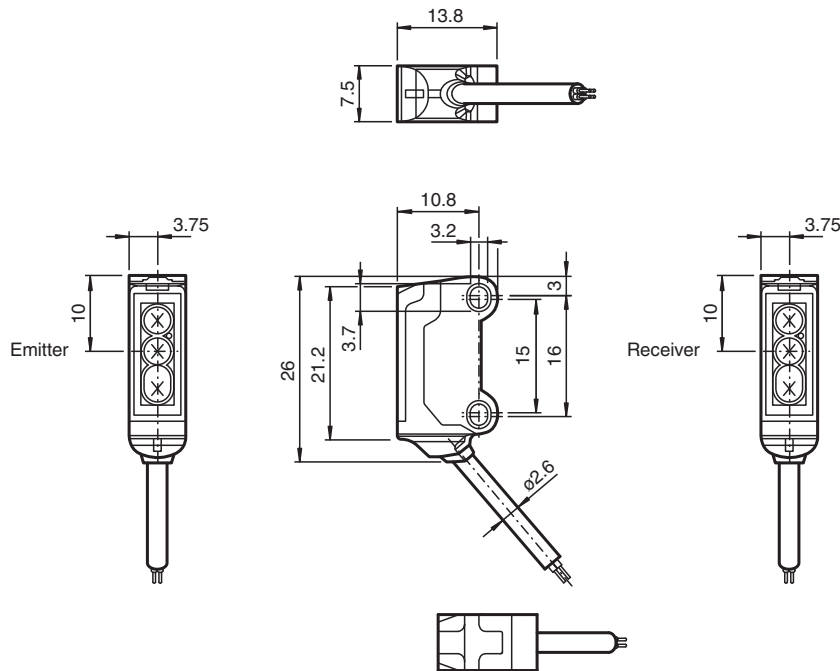

Technical Data

System components	
Emitter	OBE10M-R3-S-P-L
Receiver	OBE10M-R3-E1-P-L
General specifications	
Effective detection range	0 ... 10 m

Release date: 2023-04-04 Date of issue: 2023-04-04 Filename: 70141741_eng.pdf

Technical Data

Threshold detection range		15 m
Light source		laser diode
Light type		modulated visible red light , 680 nm
Laser nominal ratings		
Note		LASER LIGHT , DO NOT STARE INTO BEAM
Laser class		1
Wave length		680 nm
Beam divergence		> 5 mrad
Pulse length		approx. 3 μ s
Repetition rate		approx. 16.6 kHz
max. pulse energy		9.5 nJ
Diameter of the light spot		approx. 20 mm at a distance of 10 m
Opening angle		approx. 0.5 °
Optical face		frontal
Ambient light limit		EN 60947-5-2 : 30000 Lux
Functional safety related parameters		
MTTF _d		806 a
Mission Time (T _M)		20 a
Diagnostic Coverage (DC)		0 %
Indicators/operating means		
Operation indicator		LED green, statically lit Power on , short-circuit : LED green flashing (approx. 4 Hz)
Function indicator		Receiver: LED yellow, lights up when light beam is free, flashes when falling short of the operating reserve ; OFF when light beam is interrupted
Electrical specifications		
Operating voltage	U _B	12 ... 24 V
No-load supply current	I ₀	Emitter: \leq 10 mA Receiver: \leq 8 mA
Protection class		III
Input		
Test input		Test of switching function at 0 V
Switching threshold		Teach-In input
Output		
Switching type		NC contact / light on
Signal output		1 NPN output, short-circuit protected, reverse polarity protected, open collector
Switching voltage		max. 30 V DC
Switching current		max. 50 mA , resistive load
Voltage drop	U _d	\leq 1.5 V DC
Switching frequency	f	approx. 2 kHz
Response time		250 μ s
Conformity		
Product standard		EN 60947-5-2
Laser safety		EN 60825-1:2007
Approvals and certificates		
UL approval		E87056 , cULus Recognized, Class 2 Power Source
CCC approval		CCC approval / marking not required for products rated \leq 36 V
FDA approval		IEC 60825-1:2007 Complies with 21 CFR 1040.10 and 1040.11 except for deviations pursuant to Laser Notice No. 50, dated June 24, 2007
Ambient conditions		
Ambient temperature		-20 ... 60 °C (-4 ... 140 °F)
Storage temperature		-30 ... 70 °C (-22 ... 158 °F)
Mechanical specifications		
Housing width		7.5 mm
Housing height		26 mm
Housing depth		13.8 mm

Technical Data

Degree of protection	IP67
Connection	2 m fixed cable
Material	
Housing	PC/ABS and TPU
Optical face	PC
Cable	PUR
Mass	approx. 20 g per sensor
Cable length	2 m

Connection

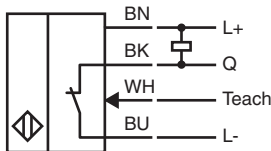
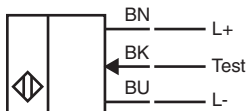

Assembly

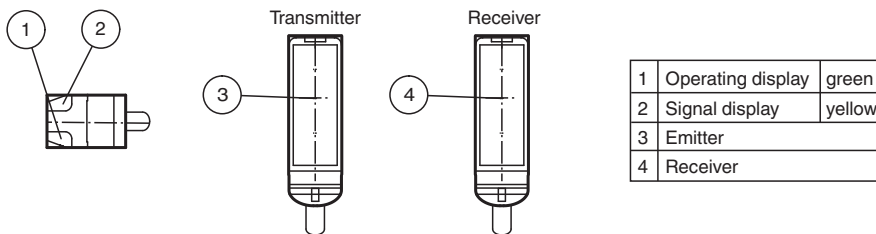

Characteristic Curve

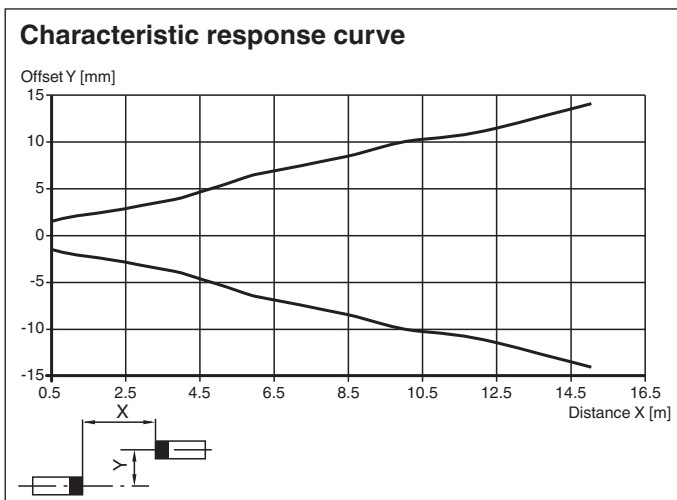

Release date: 2023-04-04 Date of issue: 2023-04-04 Filename: 70141741_eng.pdf

Characteristic Curve

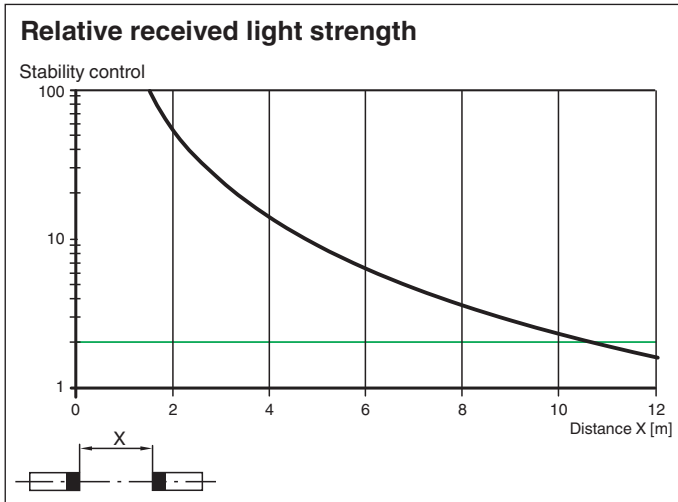

Safety Information



Safety Information

Laser Class 1 Information



The irradiation can lead to irritation especially in a dark environment. Do not point at people!
 Maintenance and repairs should only be carried out by authorized service personnel!
 Attach the device so that the warning is clearly visible and readable.
 The warning accompanies the device and should be attached in immediate proximity to the device.
 Caution – Use of controls or adjustments or performance of procedures other than those specified herein may result in hazardous radiation exposure.

Accessories

	MH-R3-01	Mounting aid for sensors from the R3 series, mounting bracket
	MH-R3-02	Mounting aid for sensors from the R3 series, mounting bracket

Release date: 2023-04-04 Date of issue: 2023-04-04 Filename: 70141741_eng.pdf

Accessories

	MH-R3-03	Mounting aid for sensors from the R3 series, mounting bracket
	MH-R3-04	Mounting aid for sensors from the R3 series, mounting bracket

Teach-In

The thru-beam sensor enables the switching points to be taught in for optimum adaptation to specific applications. This eliminates the need for additional components such as apertures.

The sensitivity of the thru-beam sensor can be adjusted using three Teach-in methods:

Position Teach

When using this Teach-in method, the following settings are made on the thru-beam sensor:

- The gain is set to an optimum value
- The signal threshold is set to a minimum

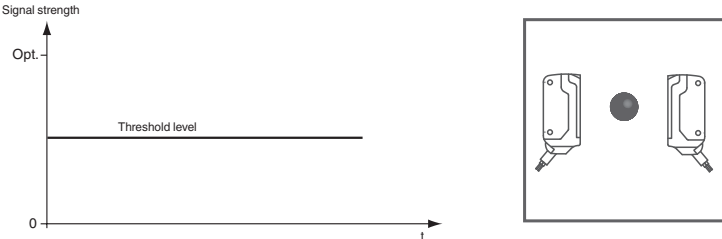

Recommended application:

This method enables minuscule particles in the beam path to be detected, and provides exceptional positioning accuracy. Make sure that there are no objects in the beam path and that the sensor is connected to the power supply.

1. Connect the white cable on the receiver (WH/IN) to the blue cable (BU/0 V) on the receiver.
The green and yellow LED indicators flash simultaneously at 2.5 Hz
2. Disconnect the white cable on the receiver (WH/IN) from the blue cable (BU/0 V) on the receiver.
The green and yellow LED indicators flash alternately at 2.5 Hz
3. The end of the Teach-in process is indicated when the green LED indicator lights up static and yellow LED blinks.

Two-Point Teach-In

When using this Teach-in method, the following settings are made on the thru-beam sensor:

- The gain is set to an optimum value
- The signal threshold is set in the center between the two taught signal values

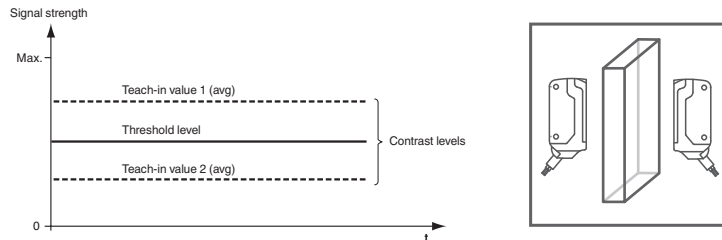

1. Make sure that there are no objects in the beam path and that the sensor is connected to the power supply.
2. Connect the white cable on the receiver (WH/IN) to the blue cable (BU/0 V) on the receiver.
The green and yellow LED indicators flash simultaneously at 2.5 Hz
3. Position the object in the beam path.
4. Disconnect the white cable on the receiver (WH/IN) from the blue cable (BU/0 V) on the receiver.
The green and yellow LED indicators flash alternately at 2.5 Hz
5. The end of the Teach-in process is indicated when the green LED indicator lights up static.

Maximum Teach-In

When using this Teach-in method, the following settings are made on the thru-beam sensor:

- The gain is set to a maximum
- The signal threshold is set to a minimum

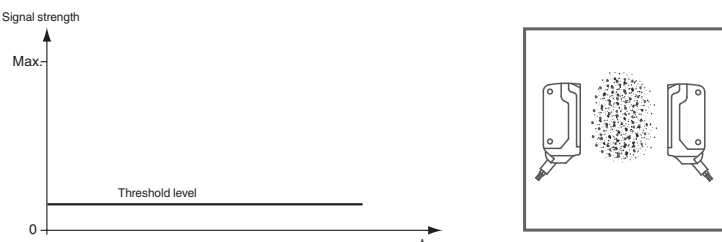

Recommended application:

Enables an object to be detected with a high excess gain. This can be useful if there is severe environmental contamination or to achieve long operating times.

Make sure that there are no objects in the beam path and that the sensor is connected to the power supply.

6. Cover the receiver or transmitter.
7. Connect the white cable on the receiver (WH/IN) to the blue cable (BU/0 V) on the receiver.

Release date: 2023-04-04 Date of issue: 2023-04-04 Filename: 70141741_eng.pdf

Thru-beam sensor (pair)

OBE10M-R3-SE1-P-L

The green and yellow LED indicators flash simultaneously at 2.5 Hz

8. Disconnect the white cable on the receiver (WH/IN) from the blue cable (BU/0 V) on the receiver.
The green and yellow LED indicators flash alternately at 2.5 Hz
9. The end of the Teach-in process is indicated when the green LED indicator lights up static.