

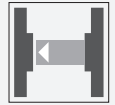

## Thru-beam sensor (pair)

### OBE2000-R2-SE1-P



- Ultra-small housing design
- 45° cable outlet for maximum mounting freedom under extremely tight space constraints
- Extremely large detection range in Long Range Mode
- Option of switching to high precision mode for greater switching accuracy

Thru-beam sensor for standard applications, miniature design, 2000 mm detection range, red light, light on, NPN output, 2 m fixed cable



## Function

The nano sensor has been developed for a broad range of applications. It offers excellent durability and is exceptionally easy to install. The housing is compact and, with its 45° cable outlet, can be installed in the smallest spaces. New functional principles and functionality open up a range of new options.

## Dimensions

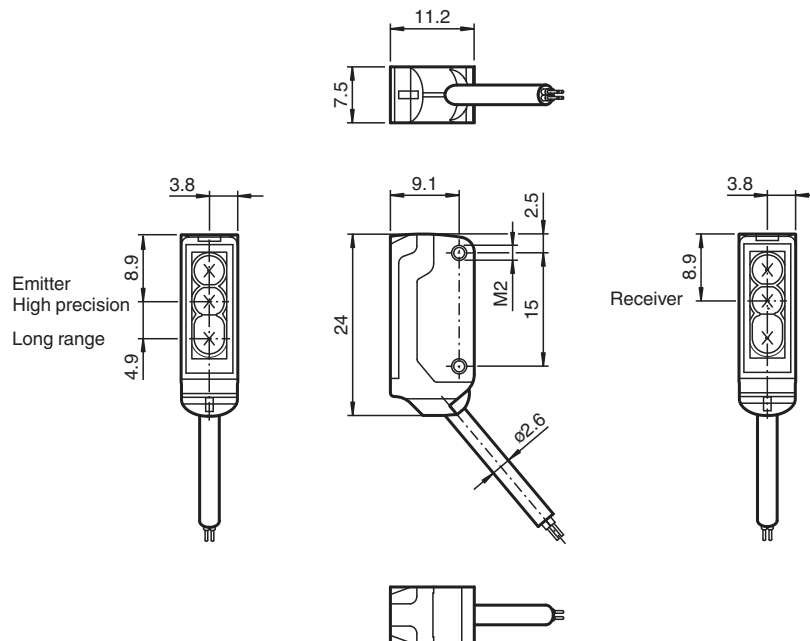

## Technical Data

### System components

Emitter	OBE2000-R2-S-P
Receiver	OBE2000-R2-E1-P

### General specifications

## Technical Data

Effective detection range		Long range mode: 0 ... 2 m High precision mode: 0 ... 200 mm
Threshold detection range		Long range mode: 2.5 m High precision mode: 300 mm
Light source		LED
Light type		modulated visible red light , 630 nm
Angle deviation		approx. 2 °
Diameter of the light spot		Long range mode: 150 mm at a distance of 2000 mm High precision mode: 0.5 mm at a distance of 50 mm
Opening angle		approx. 2 °
Optical face		frontal
Ambient light limit		EN 60947-5-2 : 30000 Lux
<b>Functional safety related parameters</b>		
MTTF <sub>d</sub>		806 a
Mission Time (T <sub>M</sub> )		20 a
Diagnostic Coverage (DC)		0 %
<b>Indicators/operating means</b>		
Operation indicator		LED green, statically lit Power on , short-circuit : LED green flashing (approx. 4 Hz)
Function indicator		Receiver: LED yellow, lights up when light beam is free, flashes when falling short of the operating reserve ; OFF when light beam is interrupted
<b>Electrical specifications</b>		
Operating voltage	U <sub>B</sub>	10 ... 30 V DC , class 2
No-load supply current	I <sub>0</sub>	Emitter: ≤ 11 mA Receiver: ≤ 8 mA
<b>Input</b>		
Control input		Emitter selection BK: not connected, Long Range mode BK: 0 V, High Precision Mode
Switching threshold		Teach-In input
<b>Output</b>		
Switching type		NC contact / light on
Signal output		1 NPN output, short-circuit protected, reverse polarity protected, open collector
Switching voltage		max. 30 V DC
Switching current		max. 50 mA
Voltage drop	U <sub>d</sub>	≤ 1.5 V DC
Switching frequency	f	approx. 800 Hz
Response time		600 μs
<b>Conformity</b>		
Product standard		EN 60947-5-2
<b>Approvals and certificates</b>		
UL approval		cULus Recognized, Class 2 Power Source
CCC approval		CCC approval / marking not required for products rated ≤36 V
<b>Ambient conditions</b>		
Ambient temperature		-25 ... 60 °C (-13 ... 140 °F)
Storage temperature		-30 ... 70 °C (-22 ... 158 °F)
<b>Mechanical specifications</b>		
Housing width		7.5 mm
Housing height		24 mm
Housing depth		11.2 mm
Degree of protection		IP67
Connection		2 m fixed cable
Material		
Housing		PC/ABS and TPU
Optical face		PC
Cable		PUR
Installation		Fixing screws , 2 x M2 allen head screws included with delivery
Mass		approx. 20 g per sensor

**Technical Data**

Cable length	2 m
--------------	-----

**Connection Assignment**

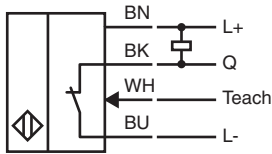
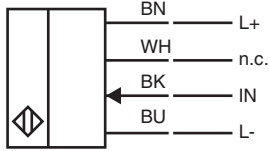

**Assembly**

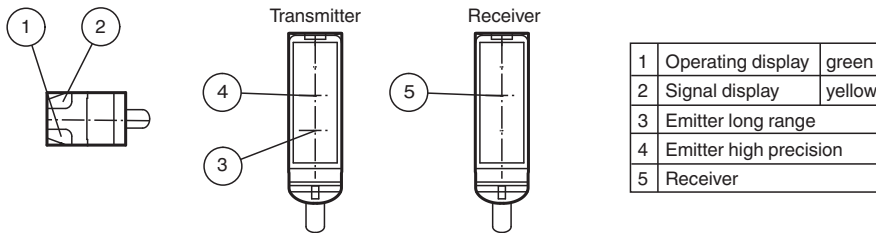

**Characteristic Curve**

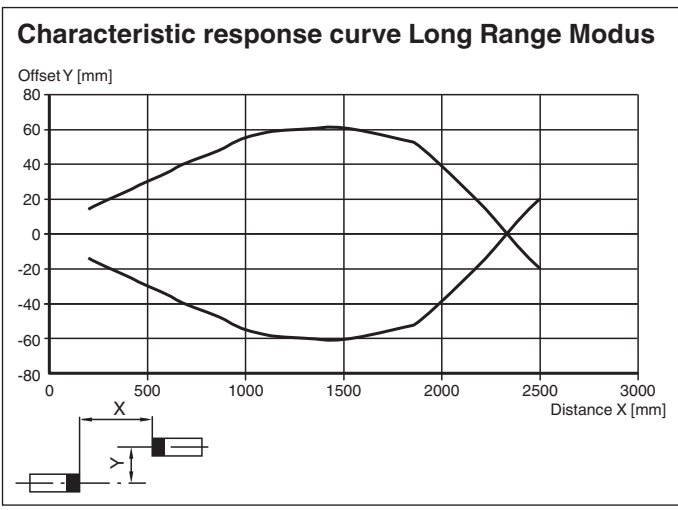

Release date: 2023-04-04 Date of issue: 2023-04-04 Filename: 70141747\_eng.pdf

**Characteristic Curve**

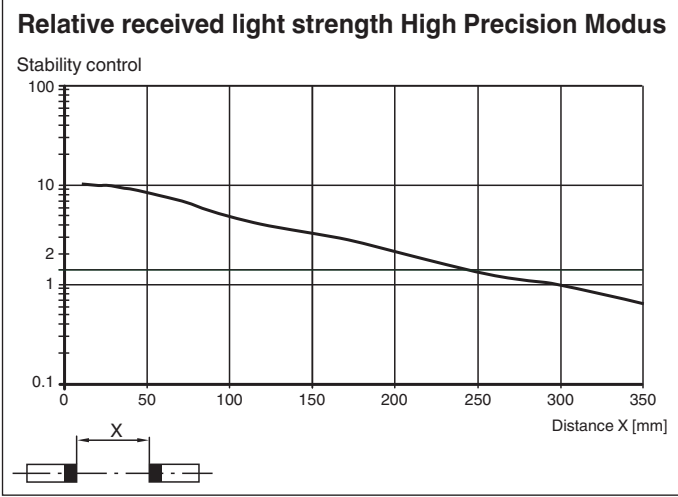
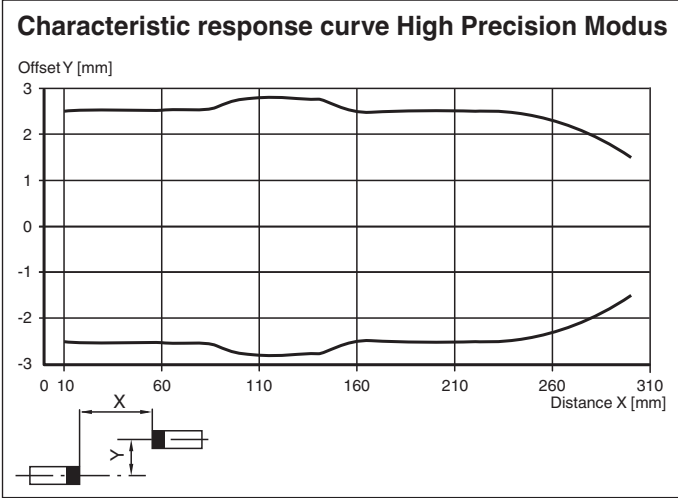
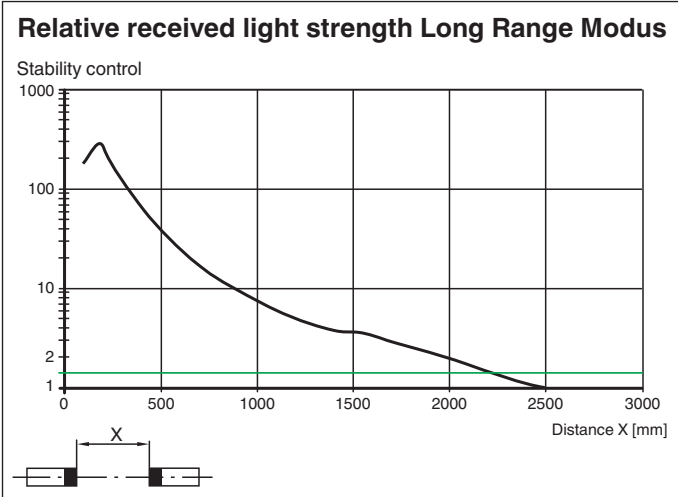

Release date: 2023-04-04 Date of issue: 2023-04-04 Filename: 70141747\_eng.pdf

## Characteristic Curve



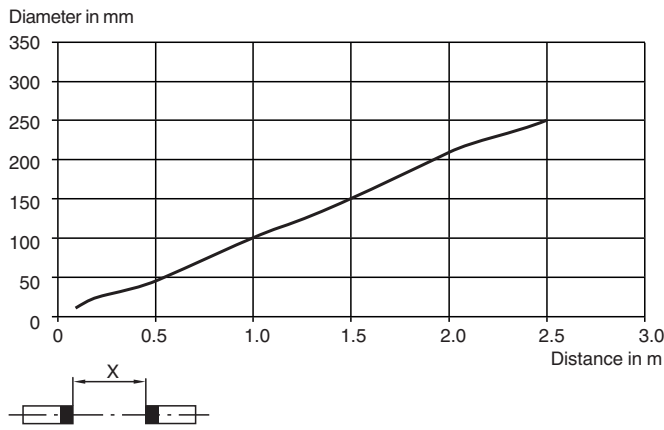

### Light spot diameter Long Range Modus

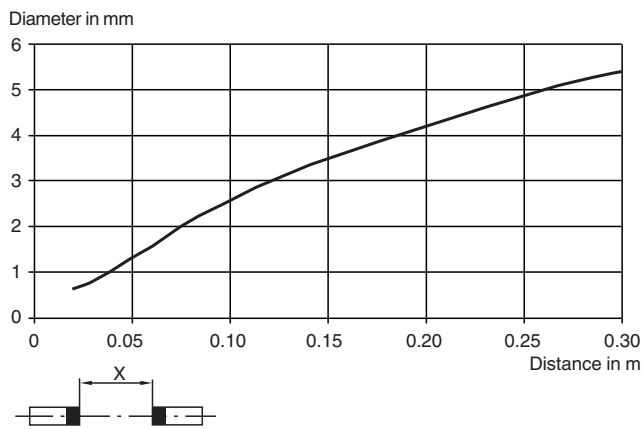

### Light spot diameter High Precision Modus



## Accessories

	<b>MH-R2-01</b>	Mounting aid for R2 series, Mounting bracket
	<b>MH-R2-02</b>	Mounting aid for R2 series, Mounting bracket
	<b>MH-R2-03</b>	Mounting aid for R2 series, Mounting bracket
	<b>MH-R2-04</b>	Mounting aid for R2 series, Mounting bracket

Release date: 2023-04-04 Date of issue: 2023-04-04 Filename: 70141747\_eng.pdf

**Teach-In**

The thru-beam sensor enables the switching points to be taught in for optimum adaptation to specific applications. This eliminates the need for additional components such as apertures.

Essentially, all Teach-in methods can be used in both "High Precision" and "High Power" operating modes.

The sensitivity of the thru-beam sensor can be adjusted using three Teach-in methods:

**Position Teach**

When using this Teach-in method, the following settings are made on the thru-beam sensor:

- The gain is set to an optimum value
- The signal threshold is set to a minimum



Recommended application:

This method enables extremely small differences in contrast to be detected, as well as minuscule particles in the beam path, and provides exceptional positioning accuracy.

The best results are achieved in "High Precision" mode.

1. Make sure that there are no objects in the beam path and that the sensor is connected to the power supply.
2. Connect the white cable on the receiver (WH/IN) to the blue cable (BU/0 V) on the receiver. The green and yellow LED indicators flash simultaneously at 2.5 Hz
3. Disconnect the white cable on the receiver (WH/IN) from the blue cable (BU/0 V) on the receiver. The green and yellow LED indicators flash alternately at 2.5 Hz
4. The end of the Teach-in process is indicated when the green LED indicator lights up solid and yellow LED blinks.

**Two-Point Teach-In**

When using this Teach-in method, the following settings are made on the thru-beam sensor:

- The gain is set to an optimum value
- The signal threshold is set in the center between the two taught signal values

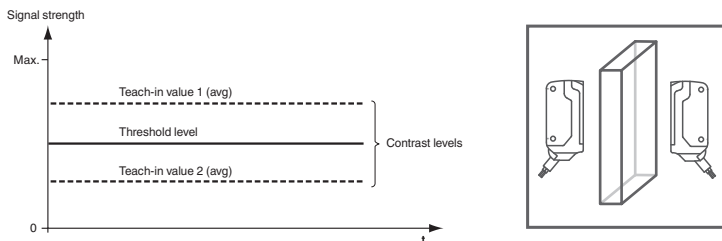

Recommended application:

Enables detection of transparent objects.

The best results are achieved in "High Precision" mode.

1. Make sure that there are no objects in the beam path and that the sensor is connected to the power supply.
2. Connect the white cable on the receiver (WH/IN) to the blue cable (BU/0 V) on the receiver. The green and yellow LED indicators flash simultaneously at 2.5 Hz
3. Position the object in the beam path.
4. Disconnect the white cable on the receiver (WH/IN) from the blue cable (BU/0 V) on the receiver. The green and yellow LED indicators flash alternately at 2.5 Hz
5. The end of the Teach-in process is indicated when the green LED indicator lights up solid.

**Maximum Teach-In**

When using this Teach-in method, the following settings are made on the thru-beam sensor:

- The gain is set to a maximum
- The signal threshold is set to a minimum

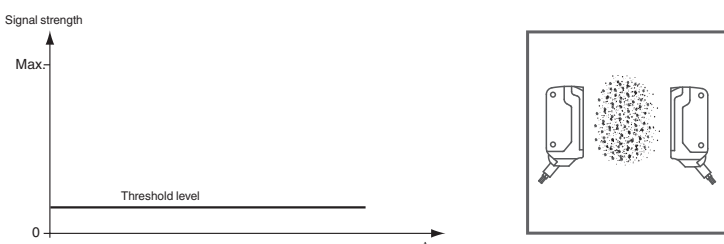

Release date: 2023-04-04 Date of issue: 2023-04-04 Filename: 70141747\_eng.pdf

### Recommended application:

Enables an object to be detected with a high excess gain. This can be useful if there is severe environmental contamination or to achieve long operating times.

The best results are achieved in "High Precision" mode.

1. Make sure that there are no objects in the beam path and that the sensor is connected to the power supply.
2. Cover the receiver or transmitter.
3. Connect the white cable on the receiver (WH/IN) to the blue cable (BU/0 V) on the receiver.  
The green and yellow LED indicators flash simultaneously at 2.5 Hz
4. Disconnect the white cable on the receiver (WH/IN) from the blue cable (BU/0 V) on the receiver.  
The green and yellow LED indicators flash alternately at 2.5 Hz
5. The end of the Teach-in process is indicated when the green LED indicator lights up solid.