

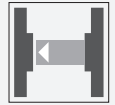

Thru-beam sensor (pair)

OBE2000-R3-SE0-P



- 45° cable outlet for maximum mounting freedom under extremely tight space constraints
- Extremely large detection range in Long Range Mode
- Option of switching to high precision mode for greater switching accuracy

Thru-beam sensor for standard applications, miniature design, 2000 mm detection range, red light, dark on, NPN output, 2 m fixed cable



Function

The nano sensor has been developed for a broad range of applications. It offers excellent durability and is exceptionally easy to install. The housing is compact and, with its 45° cable outlet, can be installed in the smallest spaces. New functional principles and functionality open up a range of new options.

Dimensions

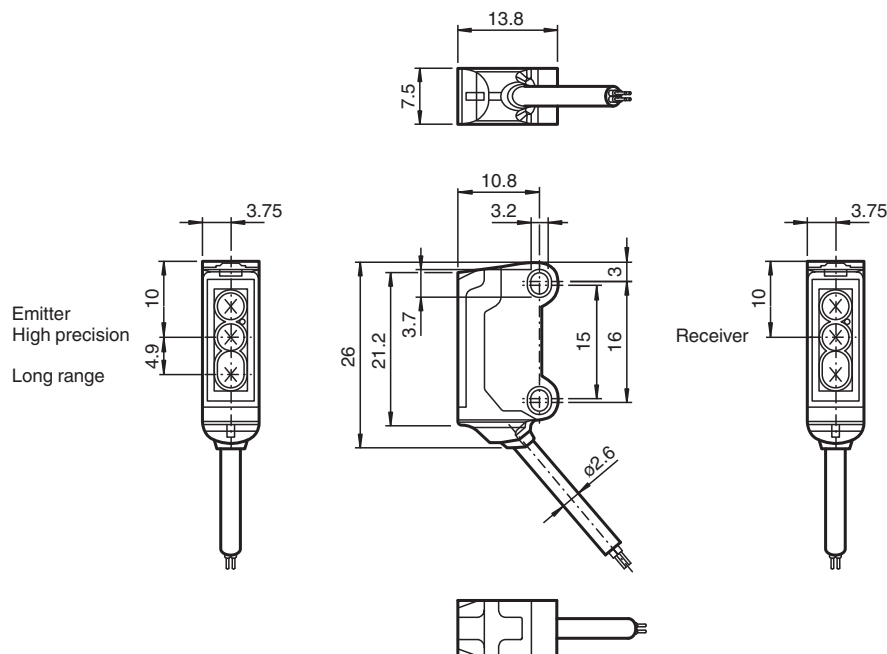

Technical Data

System components

Emitter	OBE2000-R3-S-P
Receiver	OBE2000-R3-E0-P

General specifications

Release date: 2023-03-28 Date of issue: 2023-03-28 Filename: 70141750_eng.pdf

Technical Data

Effective detection range		Long range mode: 0 ... 2 m High precision mode: 0 ... 200 mm
Threshold detection range		Long range mode: 2.5 m High precision mode: 300 mm
Light source		LED
Light type		modulated visible red light , 630 nm
Angle deviation		approx. 2 °
Diameter of the light spot		Long range mode: 150 mm at a distance of 2000 mm High precision mode: 0.5 mm at a distance of 50 mm
Opening angle		approx. 2 °
Optical face		frontal
Ambient light limit		EN 60947-5-2 : 30000 Lux
Functional safety related parameters		
MTTF _d		806 a
Mission Time (T _M)		20 a
Diagnostic Coverage (DC)		0 %
Indicators/operating means		
Operation indicator		LED green, statically lit Power on , short-circuit : LED green flashing (approx. 4 Hz)
Function indicator		Receiver: LED yellow, lights up when light beam is free, flashes when falling short of the operating reserve ; OFF when light beam is interrupted
Electrical specifications		
Operating voltage	U _B	10 ... 30 V DC , class 2
No-load supply current	I ₀	Emitter: ≤ 11 mA Receiver: ≤ 8 mA
Input		
Control input		Emitter selection BK: not connected, Long Range mode BK: 0 V, High Precision Mode
Switching threshold		Teach-In input
Output		
Switching type		NO contact / dark on
Signal output		1 NPN output, short-circuit protected, reverse polarity protected, open collector
Switching voltage		max. 30 V DC
Switching current		max. 50 mA , resistive load
Voltage drop	U _d	≤ 1.5 V DC
Switching frequency	f	approx. 800 Hz
Response time		600 μs
Conformity		
Product standard		EN 60947-5-2
Approvals and certificates		
UL approval		cULus Recognized, Class 2 Power Source
CCC approval		CCC approval / marking not required for products rated ≤36 V
Ambient conditions		
Ambient temperature		-25 ... 60 °C (-13 ... 140 °F)
Storage temperature		-30 ... 70 °C (-22 ... 158 °F)
Mechanical specifications		
Housing width		7.5 mm
Housing height		26 mm
Housing depth		13.8 mm
Degree of protection		IP67
Connection		2 m fixed cable
Material		
Housing		PC/ABS and TPU
Optical face		PC
Cable		PUR
Mass		approx. 20 g per sensor
Cable length		2 m

Connection Assignment

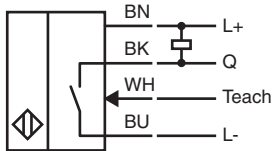
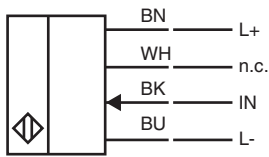

Assembly

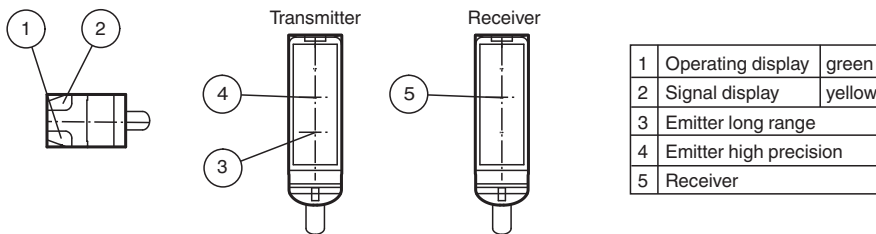

Characteristic Curve

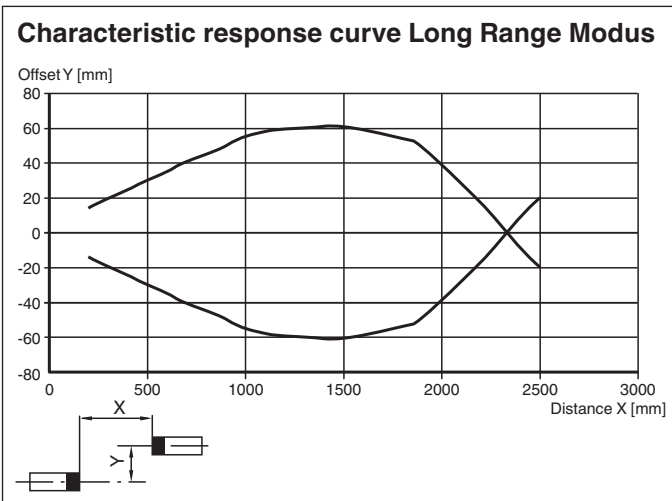

Release date: 2023-03-28 Date of issue: 2023-03-28 Filename: 70141750_eng.pdf

Characteristic Curve

Relative received light strength Long Range Modus

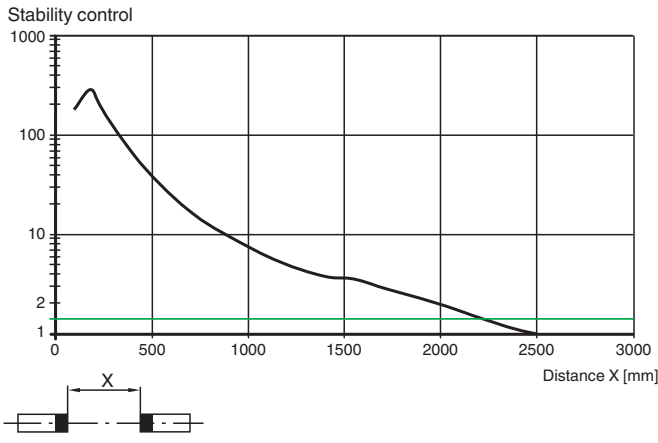

Characteristic response curve High Precision Modus

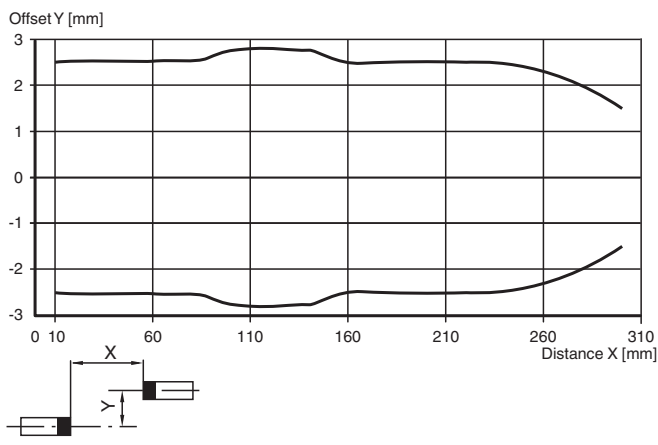

Relative received light strength High Precision Modus

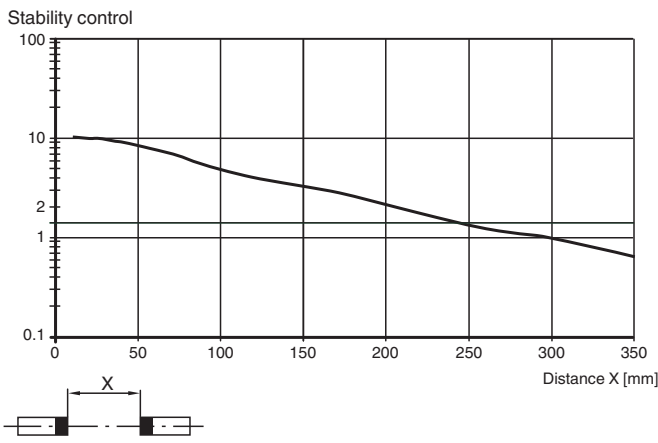

Release date: 2023-03-28 Date of issue: 2023-03-28 Filename: 70141750_eng.pdf

Characteristic Curve

Light spot diameter Long Range Modus

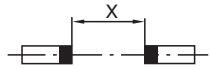
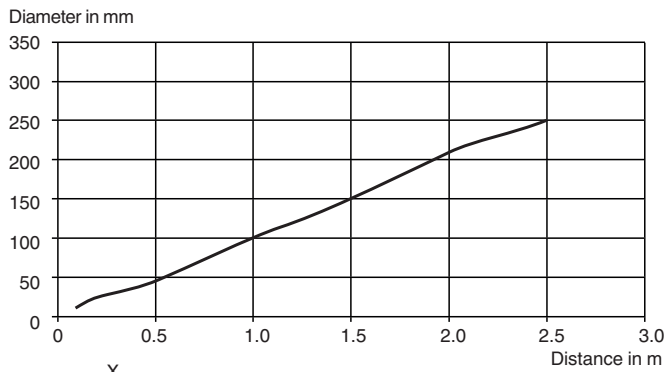

Light spot diameter High Precision Modus

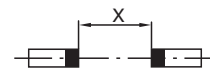
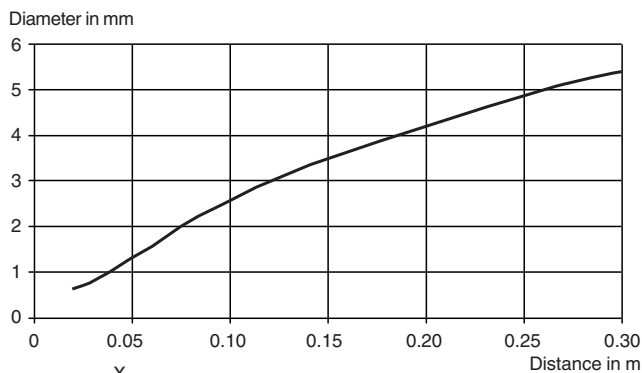

Release date: 2023-03-28 Date of issue: 2023-03-28 Filename: 70141750_eng.pdf

Teach-In

The thru-beam sensor enables the switching points to be taught in for optimum adaptation to specific applications. This eliminates the need for additional components such as apertures.

Essentially, all Teach-in methods can be used in both "High Precision" and "High Power" operating modes.

The sensitivity of the thru-beam sensor can be adjusted using three Teach-in methods:

Position Teach

When using this Teach-in method, the following settings are made on the thru-beam sensor:

- The gain is set to an optimum value
- The signal threshold is set to a minimum

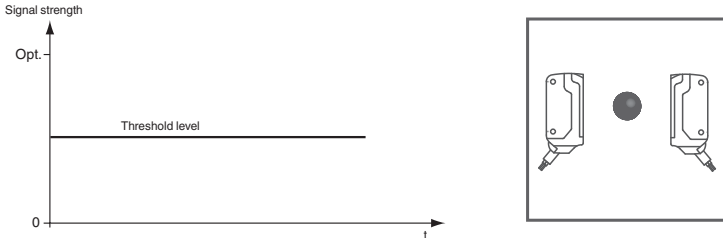

Recommended application:

This method enables extremely small differences in contrast to be detected, as well as minuscule particles in the beam path, and provides exceptional positioning accuracy.

The best results are achieved in "High Precision" mode.

1. Make sure that there are no objects in the beam path and that the sensor is connected to the power supply.
2. Connect the white cable on the receiver (WH/IN) to the blue cable (BU/0 V) on the receiver. The green and yellow LED indicators flash simultaneously at 2.5 Hz
3. Disconnect the white cable on the receiver (WH/IN) from the blue cable (BU/0 V) on the receiver. The green and yellow LED indicators flash alternately at 2.5 Hz
4. The end of the Teach-in process is indicated when the green LED indicator lights up solid and yellow LED blinks.

Two-Point Teach-In

When using this Teach-in method, the following settings are made on the thru-beam sensor:

- The gain is set to an optimum value
- The signal threshold is set in the center between the two taught signal values

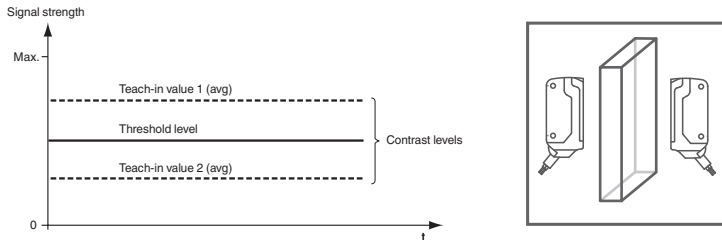

Recommended application:

Enables detection of transparent objects.

The best results are achieved in "High Precision" mode.

1. Make sure that there are no objects in the beam path and that the sensor is connected to the power supply.
2. Connect the white cable on the receiver (WH/IN) to the blue cable (BU/0 V) on the receiver. The green and yellow LED indicators flash simultaneously at 2.5 Hz
3. Position the object in the beam path.
4. Disconnect the white cable on the receiver (WH/IN) from the blue cable (BU/0 V) on the receiver. The green and yellow LED indicators flash alternately at 2.5 Hz
5. The end of the Teach-in process is indicated when the green LED indicator lights up solid.

Maximum Teach-In

When using this Teach-in method, the following settings are made on the thru-beam sensor:

- The gain is set to a maximum
- The signal threshold is set to a minimum

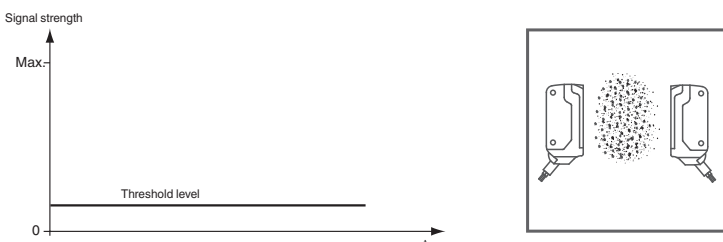

Release date: 2023-03-28 Date of issue: 2023-03-28 Filename: 70141750_eng.pdf

Recommended application:

Enables an object to be detected with a high excess gain. This can be useful if there is severe environmental contamination or to achieve long operating times.

The best results are achieved in "High Precision" mode.

1. Make sure that there are no objects in the beam path and that the sensor is connected to the power supply.
2. Cover the receiver or transmitter.
3. Connect the white cable on the receiver (WH/IN) to the blue cable (BU/0 V) on the receiver.
The green and yellow LED indicators flash simultaneously at 2.5 Hz
4. Disconnect the white cable on the receiver (WH/IN) from the blue cable (BU/0 V) on the receiver.
The green and yellow LED indicators flash alternately at 2.5 Hz
5. The end of the Teach-in process is indicated when the green LED indicator lights up solid.