



Thru-beam sensor (pair)

OBE2000-R3-SE2-0,2M-V31-P



- 45° cable outlet for maximum mounting freedom under extremely tight space constraints
- Extremely large detection range in Long Range Mode
- Option of switching to high precision mode for greater switching accuracy

Thru-beam sensor for standard applications, miniature design, 2000 mm detection range, red light, dark on, PNP output, 200 mm fixed cable with plug M8, 4-pin



Function

The nano sensor has been developed for a broad range of applications. It offers excellent durability and is exceptionally easy to install. The housing is compact and, with its 45° cable outlet, can be installed in the smallest spaces. New functional principles and functionality open up a range of new options.

Dimensions

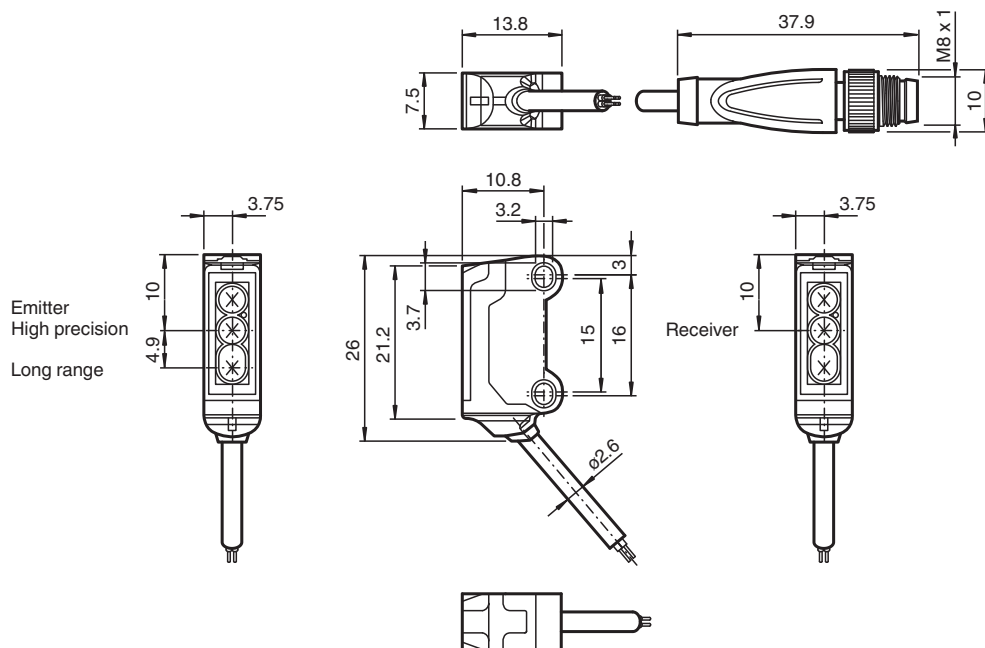

Technical Data

System components

| | |
|----------|--------------------------|
| Emitter | OBE2000-R3-S-0,2M-V31-P |
| Receiver | OBE2000-R3-E2-0,2M-V31-P |

General specifications

Technical Data

| | | |
|---|----------------|---|
| Effective detection range | | Long range mode: 0 ... 2 m High precision mode: 0 ... 200 mm |
| Threshold detection range | | Long range mode: 2.5 m High precision mode: 300 mm |
| Light source | | LED |
| Light type | | modulated visible red light , 630 nm |
| Angle deviation | | approx. 2 ° |
| Diameter of the light spot | | Long range mode: 150 mm at a distance of 2000 mm High precision mode: 0.5 mm at a distance of 50 mm |
| Opening angle | | approx. 2 ° |
| Optical face | | frontal |
| Ambient light limit | | EN 60947-5-2 : 30000 Lux |
| Functional safety related parameters | | |
| MTTF _d | | 806 a |
| Mission Time (T _M) | | 20 a |
| Diagnostic Coverage (DC) | | 0 % |
| Indicators/operating means | | |
| Operation indicator | | LED green, statically lit Power on , short-circuit : LED green flashing (approx. 4 Hz) |
| Function indicator | | Receiver: LED yellow, lights up when light beam is free, flashes when falling short of the operating reserve ; OFF when light beam is interrupted |
| Electrical specifications | | |
| Operating voltage | U _B | 10 ... 30 V DC , class 2 |
| No-load supply current | I ₀ | Emitter: ≤ 11 mA Receiver: ≤ 8 mA |
| Input | | |
| Control input | | Emitter selection BK: not connected, Long Range mode BK: 0 V, High Precision Mode |
| Switching threshold | | Teach-In input |
| Output | | |
| Switching type | | NO contact / dark on |
| Signal output | | 1 PNP output, short-circuit protected, reverse polarity protected, open collector |
| Switching voltage | | max. 30 V DC |
| Switching current | | max. 50 mA , resistive load |
| Voltage drop | U _d | ≤ 1.5 V DC |
| Switching frequency | f | approx. 800 Hz |
| Response time | | 600 μs |
| Conformity | | |
| Product standard | | EN 60947-5-2 |
| Approvals and certificates | | |
| UL approval | | cULus Recognized, Class 2 Power Source |
| CCC approval | | CCC approval / marking not required for products rated ≤36 V |
| Ambient conditions | | |
| Ambient temperature | | -25 ... 60 °C (-13 ... 140 °F) |
| Storage temperature | | -30 ... 70 °C (-22 ... 158 °F) |
| Mechanical specifications | | |
| Housing width | | 7.5 mm |
| Housing height | | 26 mm |
| Housing depth | | 13.8 mm |
| Degree of protection | | IP67 |
| Connection | | 200 mm fixed cable with 4-pin, M8x1 connector |
| Material | | |
| Housing | | PC/ABS and TPU |
| Optical face | | PC |
| Cable | | PUR |
| Mass | | approx. 20 g per sensor |
| Cable length | | 200 mm |

Connection Assignment

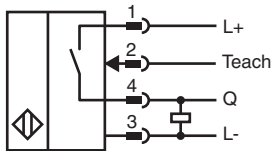
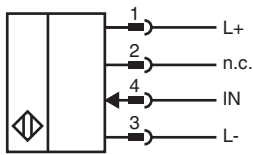

Assembly

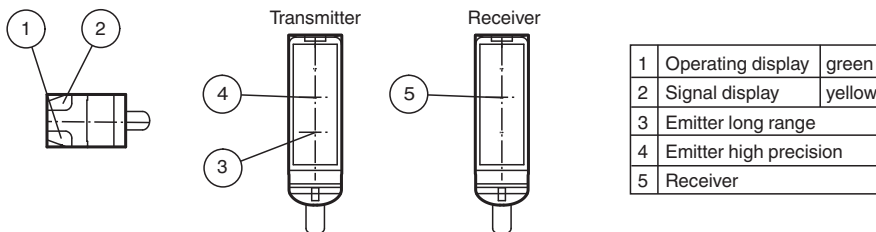

Characteristic Curve

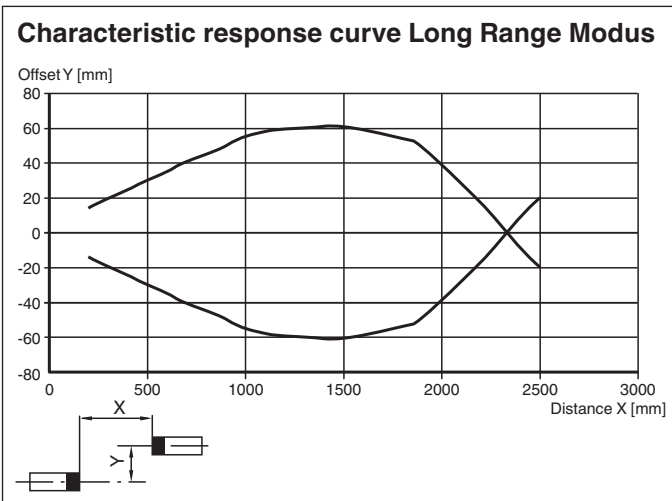

Release date: 2023-03-28 Date of issue: 2023-03-28 Filename: 70141760_eng.pdf

Characteristic Curve

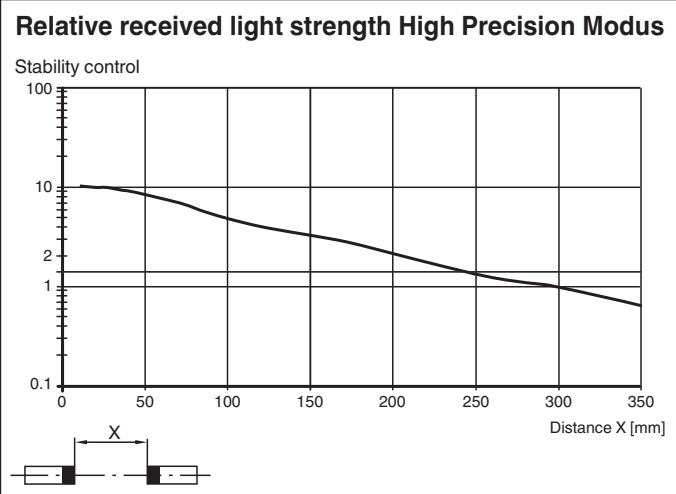
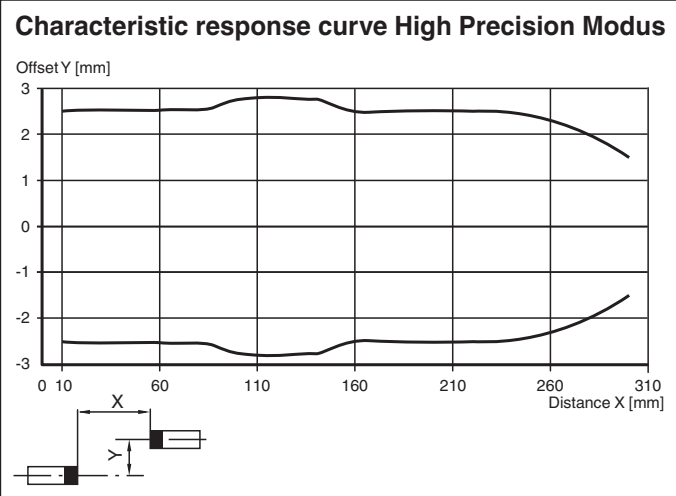
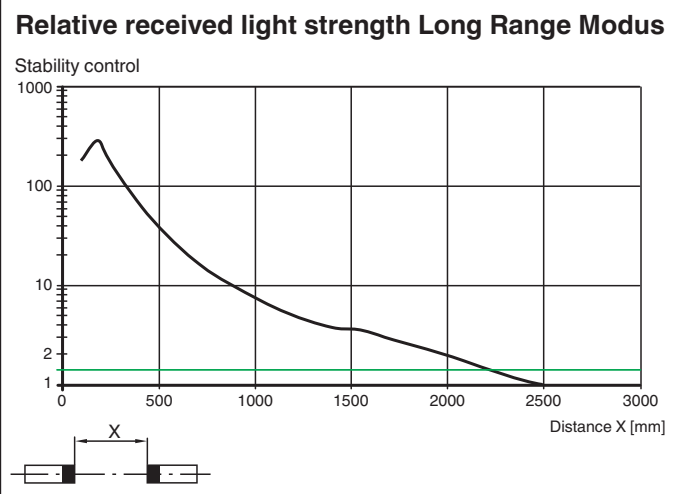

Release date: 2023-03-28 Date of issue: 2023-03-28 Filename: 70141760_eng.pdf

Characteristic Curve

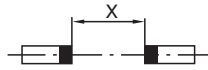
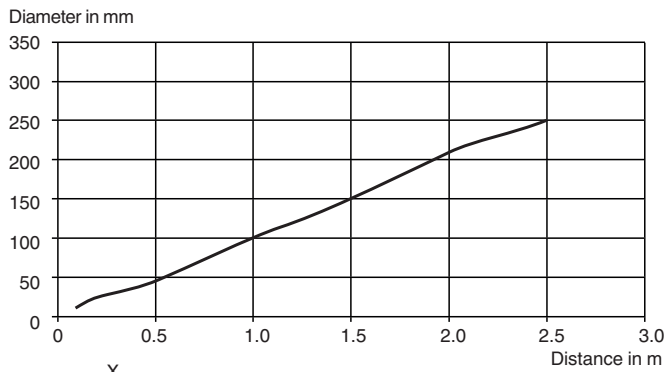

Light spot diameter Long Range Modus

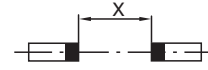
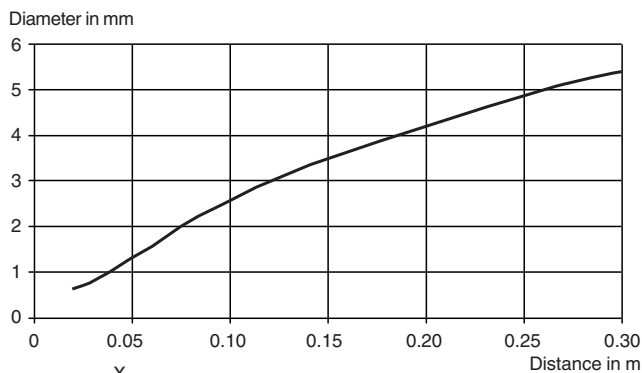

Light spot diameter High Precision Modus



Accessories

| | | |
|---|----------------------|--|
|  | V31-GM-2M-PUR | Female cordset single-ended M8 straight A-coded, 4-pin, PUR cable grey |
|  | V31-WM-2M-PUR | Female cordset single-ended M8 angled A-coded, 4-pin, PUR cable grey |

Teach-In

The thru-beam sensor enables the switching points to be taught in for optimum adaptation to specific applications. This eliminates the need for additional components such as apertures.

Essentially, all Teach-in methods can be used in both "High Precision" and "High Power" operating modes.

The sensitivity of the thru-beam sensor can be adjusted using three Teach-in methods:

Position Teach

When using this Teach-in method, the following settings are made on the thru-beam sensor:

- The gain is set to an optimum value
- The signal threshold is set to a minimum

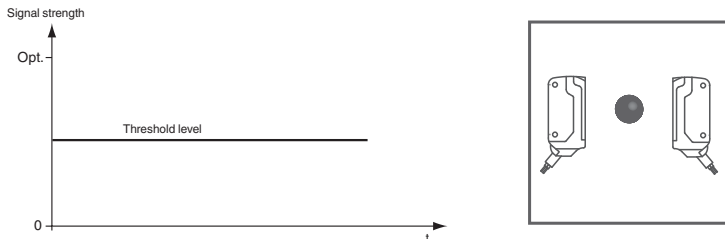

Recommended application:

This method enables extremely small differences in contrast to be detected, as well as minuscule particles in the beam path, and provides exceptional positioning accuracy.

The best results are achieved in "High Precision" mode.

1. Make sure that there are no objects in the beam path and that the sensor is connected to the power supply.
2. Connect the white cable on the receiver (WH/IN) to the blue cable (BU/0 V) on the receiver.
The green and yellow LED indicators flash simultaneously at 2.5 Hz
3. Disconnect the white cable on the receiver (WH/IN) from the blue cable (BU/0 V) on the receiver.
The green and yellow LED indicators flash alternately at 2.5 Hz
4. The end of the Teach-in process is indicated when the green LED indicator lights up solid and yellow LED blinks.

Two-Point Teach-In

When using this Teach-in method, the following settings are made on the thru-beam sensor:

- The gain is set to an optimum value
- The signal threshold is set in the center between the two taught signal values

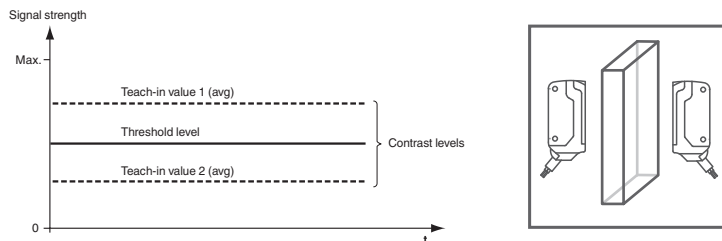

Recommended application:

Enables detection of transparent objects.

The best results are achieved in "High Precision" mode.

1. Make sure that there are no objects in the beam path and that the sensor is connected to the power supply.
2. Connect the white cable on the receiver (WH/IN) to the blue cable (BU/0 V) on the receiver.
The green and yellow LED indicators flash simultaneously at 2.5 Hz
3. Position the object in the beam path.
4. Disconnect the white cable on the receiver (WH/IN) from the blue cable (BU/0 V) on the receiver.
The green and yellow LED indicators flash alternately at 2.5 Hz
5. The end of the Teach-in process is indicated when the green LED indicator lights up solid.

Maximum Teach-In

When using this Teach-in method, the following settings are made on the thru-beam sensor:

- The gain is set to a maximum
- The signal threshold is set to a minimum

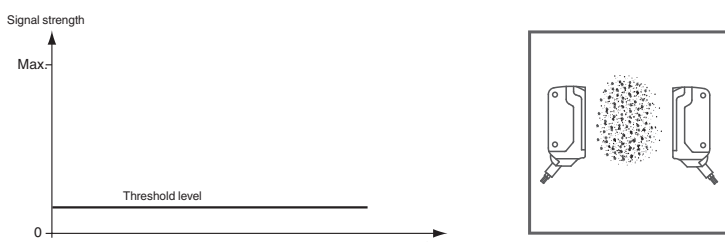

Recommended application:

Enables an object to be detected with a high excess gain. This can be useful if there is severe environmental contamination or to achieve long operating times.

The best results are achieved in "High Precision" mode.

1. Make sure that there are no objects in the beam path and that the sensor is connected to the power supply.
2. Cover the receiver or transmitter.
3. Connect the white cable on the receiver (WH/IN) to the blue cable (BU/0 V) on the receiver.
The green and yellow LED indicators flash simultaneously at 2.5 Hz
4. Disconnect the white cable on the receiver (WH/IN) from the blue cable (BU/0 V) on the receiver.
The green and yellow LED indicators flash alternately at 2.5 Hz
5. The end of the Teach-in process is indicated when the green LED indicator lights up solid.