



Retroreflective sensor OBR2000-R2-E2-P-L



- Ultra-small housing design
- DuraBeam Laser Sensors - durable and employable like an LED
- 45° cable outlet for maximum mounting freedom under extremely tight space constraints

Laser retroreflective sensor, ultra-small design with M2 mounting, polarization filter, 2000 mm detection range, dark on, PNP output, 2 m fixed cable



Function

The nano sensor has been developed for a broad range of applications. It offers excellent durability and is exceptionally easy to install. The housing is compact and, with its 45° cable outlet, can be installed in the smallest spaces. New functional principles and functionality open up a range of new options.

Dimensions

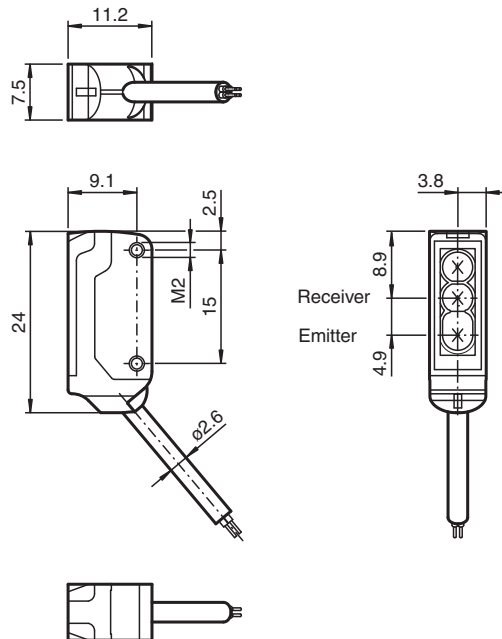

Technical Data

General specifications

Effective detection range	0 ... 2 m
Reflector distance	40 ... 2000 mm
Threshold detection range	2.3 m
Reference target	H40 reflector

Release date: 2023-03-28 Date of issue: 2023-03-28 Filename: 70141815_eng.pdf

Technical Data

Light source	laser diode	
Light type	modulated visible red light , 680 nm	
Polarization filter	yes	
Laser nominal ratings		
Note	LASER LIGHT , DO NOT STARE INTO BEAM	
Laser class	1	
Wave length	680 nm	
Beam divergence	> 5 mrad	
Pulse length	approx. 3 μ s	
Repetition rate	approx. 16.6 kHz	
max. pulse energy	8 nJ	
Diameter of the light spot	approx. 35 mm at a distance of 2000 mm	
Opening angle	approx. 0.5 °	
Optical face	frontal	
Ambient light limit	EN 60947-5-2 : 30000 Lux	
Functional safety related parameters		
MTTF _d	800 a	
Mission Time (T _M)	20 a	
Diagnostic Coverage (DC)	0 %	
Indicators/operating means		
Operation indicator	LED green, statically lit Power on , short-circuit : LED green flashing (approx. 4 Hz)	
Function indicator	LED yellow: lights up when receiving the light beam ; flashes when falling short of the operating reserve; OFF when light beam is interrupted	
Electrical specifications		
Operating voltage	U _B	12 ... 24 V
No-load supply current	I ₀	< 10 mA
Protection class	III	
Output		
Switching type	NO contact / dark-on	
Signal output	1 PNP output, short-circuit protected, reverse polarity protected, open collector	
Switching voltage	max. 30 V DC	
Switching current	max. 50 mA , resistive load	
Voltage drop	U _d	≤ 1.5 V DC
Switching frequency	f	approx. 2 kHz
Response time	250 μ s	
Conformity		
Product standard	EN 60947-5-2	
Laser safety	EN 60825-1:2007	
Approvals and certificates		
UL approval	E87056 , cULus Recognized, Class 2 Power Source	
CCC approval	CCC approval / marking not required for products rated ≤36 V	
FDA approval	IEC 60825-1:2007 Complies with 21 CFR 1040.10 and 1040.11 except for deviations pursuant to Laser Notice No. 50, dated June 24, 2007	
Ambient conditions		
Ambient temperature	-20 ... 60 °C (-4 ... 140 °F)	
Storage temperature	-30 ... 70 °C (-22 ... 158 °F)	
Mechanical specifications		
Housing width	7.5 mm	
Housing height	24 mm	
Housing depth	11.2 mm	
Degree of protection	IP67	
Connection	2 m fixed cable	
Material		
Housing	PC/ABS and TPU	

Release date: 2023-03-28 Date of issue: 2023-03-28 Filename: 70141815_eng.pdf

Technical Data

Optical face	PMMA
Cable	PUR
Installation	Fixing screws , 2 x M2 allen head screws included with delivery
Mass	approx. 20 g
Cable length	2 m

Connection

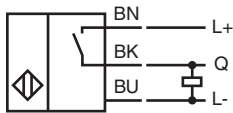

Assembly

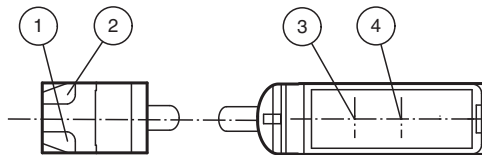

1	Operating display	green
2	Signal display	yellow
3	Emitter	
4	Receiver	

Characteristic Curve

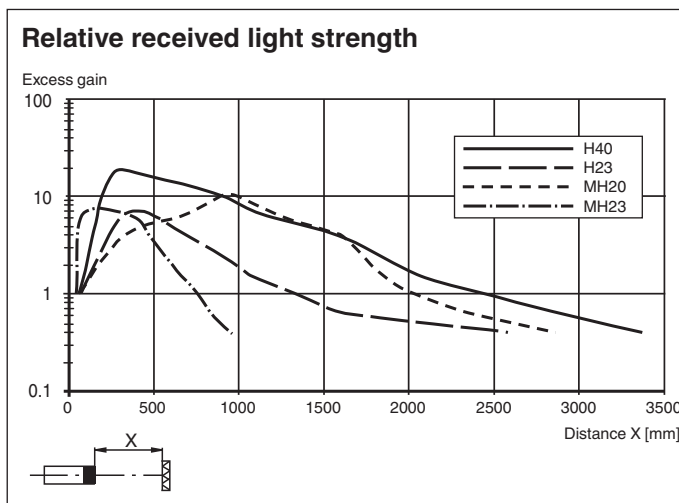

Release date: 2023-03-28 Date of issue: 2023-03-28 Filename: 70141815_eng.pdf

Safety Information

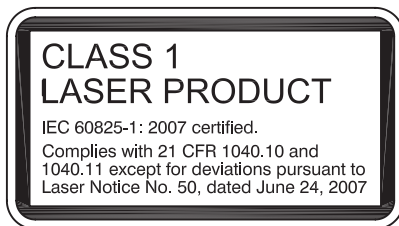

Safety Information

Laser Class 1 Information









The irradiation can lead to irritation especially in a dark environment. Do not point at people!
Maintenance and repairs should only be carried out by authorized service personnel!

Attach the device so that the warning is clearly visible and readable.

The warning accompanies the device and should be attached in immediate proximity to the device.

Caution – Use of controls or adjustments or performance of procedures other than those specified herein may result in hazardous radiation exposure.

Accessories

	MH-R2-01	Mounting aid for R2 series, Mounting bracket
	MH-R2-02	Mounting aid for R2 series, Mounting bracket
	MH-R2-03	Mounting aid for R2 series, Mounting bracket
	MH-R2-04	Mounting aid for R2 series, Mounting bracket
	REF-H40	Reflector, rectangular 47.5 mm x 23.5 mm, mounting holes, fixing strap
	REF-H23	Reflector with mounting holes
	REF-MH20	Reflector with Micro-structure, rectangular 32 mm x 20 mm, mounting holes
	REF-MH23	Reflector with Micro-structure, rectangular 23 mm x 13.8 mm, diagonal mounting hole

Release date: 2023-03-28 Date of issue: 2023-03-28 Filename: 70141815_eng.pdf