



Triangulation sensor (BGS)

OBT15-R3-E2-0,2M-V3-P



- 45° cable outlet for maximum mounting freedom under extremely tight space constraints
- Extremely small light spot for very high switching point accuracy
- Highly visible light spot, even on dark materials
- Precision object detection, almost irrespective of the color

Triangulation sensor with background suppression for standard applications, miniature design, 15 mm detection range, red light, light on, PNP output, 200 mm fixed cable with plug M8, 3-pin



Function

The nano sensor has been developed for a broad range of applications. It offers excellent durability and is exceptionally easy to install. The housing is compact and, with its 45° cable outlet, can be installed in the smallest spaces. New functional principles and functionality open up a range of new options.

Dimensions

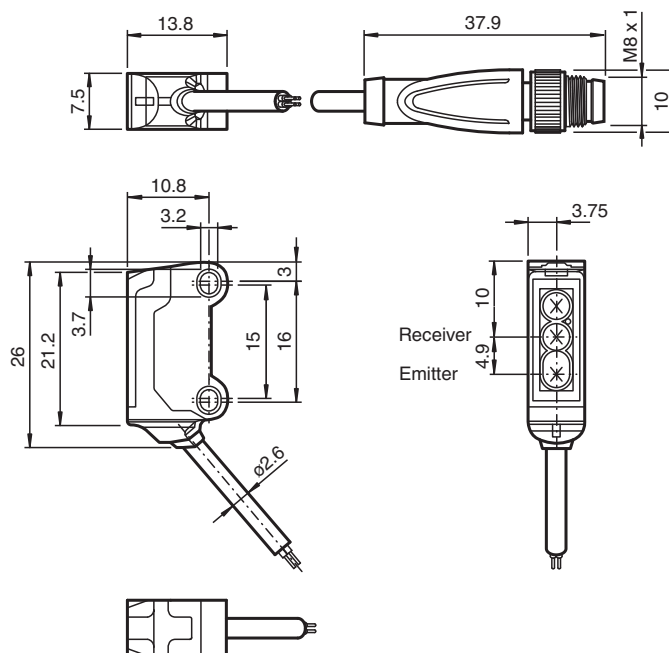

Technical Data

General specifications

Detection range	2 ... 15 mm
Reference target	standard white, 100 mm x 100 mm
Light source	LED
Light type	modulated visible red light , 630 nm

Technical Data

Black-white difference (6 %/90 %)		< 5 % at 15 mm
Angle deviation		approx. 2 °
Diameter of the light spot		approx. 2 mm at a distance of 15 mm
Opening angle		approx. 2 °
Optical face		frontal
Ambient light limit		EN 60947-5-2 : 30000 Lux
Functional safety related parameters		
MTTF _d		800 a
Mission Time (T _M)		20 a
Diagnostic Coverage (DC)		0 %
Indicators/operating means		
Operation indicator		LED green, statically lit Power on , short-circuit : LED green flashing (approx. 4 Hz)
Function indicator		LED yellow ON: lights when object is detected
Electrical specifications		
Operating voltage	U _B	10 ... 30 V DC , class 2
No-load supply current	I ₀	< 10 mA
Output		
Switching type		NO contact / light on
Signal output		1 PNP output, short-circuit protected, reverse polarity protected, open collector
Switching voltage		max. 30 V DC
Switching current		max. 50 mA , resistive load
Voltage drop	U _d	≤ 1.5 V DC
Switching frequency	f	approx. 800 Hz
Response time		600 μs
Conformity		
Product standard		EN 60947-5-2
Approvals and certificates		
UL approval		cULus Recognized, Class 2 Power Source
CCC approval		CCC approval / marking not required for products rated ≤36 V
Ambient conditions		
Ambient temperature		-25 ... 60 °C (-13 ... 140 °F)
Storage temperature		-30 ... 70 °C (-22 ... 158 °F)
Mechanical specifications		
Housing width		7.5 mm
Housing height		26 mm
Housing depth		13.8 mm
Degree of protection		IP67
Connection		200 mm fixed cable with 3-pin, M8 x 1 connector
Material		
Housing		PC/ABS and TPU
Optical face		PC
Cable		PUR
Mass		approx. 20 g
Cable length		200 mm

Connection Assignment

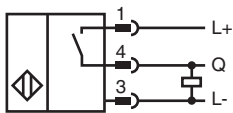

Connection Assignment



Wire colors in accordance with EN 60947-5-2

1	BN	(brown)
3	BU	(blue)
4	BK	(black)

Assembly

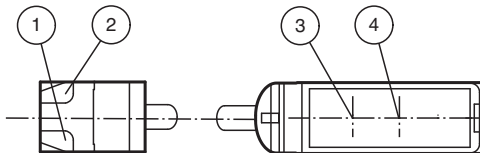

1	Operating display	green
2	Signal display	yellow
3	Emitter	
4	Receiver	

Characteristic Curve

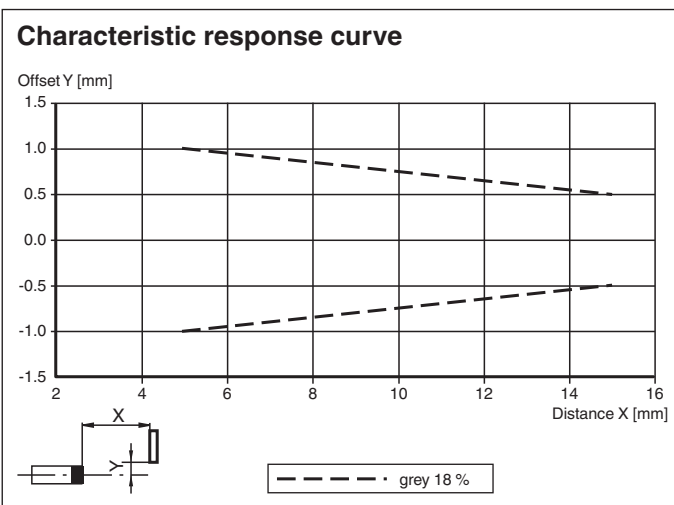



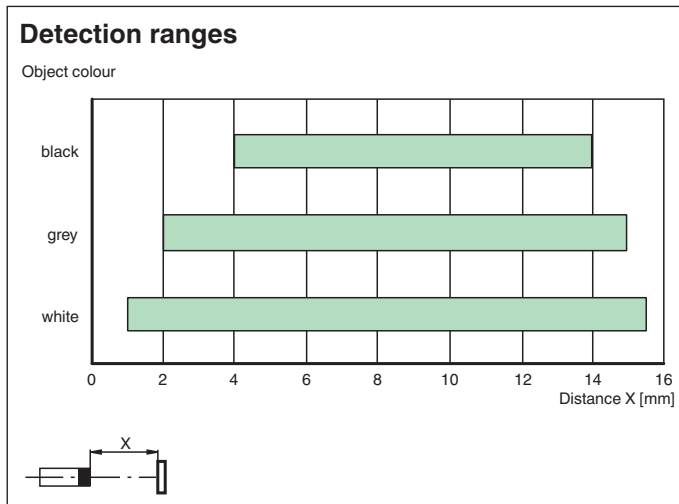

Release date: 2023-09-06 Date of issue: 2023-09-06 Filename: 70141857_eng.pdf

Characteristic Curve



Accessories

	MH-R3-01	Mounting aid for sensors from the R3 series, mounting bracket
	MH-R3-02	Mounting aid for sensors from the R3 series, mounting bracket
	MH-R3-03	Mounting aid for sensors from the R3 series, mounting bracket
	MH-R3-04	Mounting aid for sensors from the R3 series, mounting bracket
	V3-WM-2M-PUR	Female cordset single-ended M8 angled A-coded, 3-pin, PUR cable grey