



## Triangulation sensor (BGS) OBT30-R2-E2-0,2M-V31-P-L



- Ultra-small housing design
- DuraBeam Laser Sensors - durable and employable like an LED
- 45° cable outlet for maximum mounting freedom under extremely tight space constraints
- Precision object detection, almost irrespective of the color

Laser triangulation sensor with background suppression, ultra-small design with M2 mounting, 30 mm sensing range, light on, PNP output, 200 mm fixed cable with plug M8, 4-pin



### Function

The R2 series nano sensor has been developed for a broad range of applications. It offers excellent durability and is exceptionally easy to install. The housing is compact and, with its 45° cable outlet, can be installed in the smallest spaces. New functional principles and functionality open up a range of new options. The DuraBeam laser sensors are durable and can be used in the same way as a standard sensor.

### Dimensions

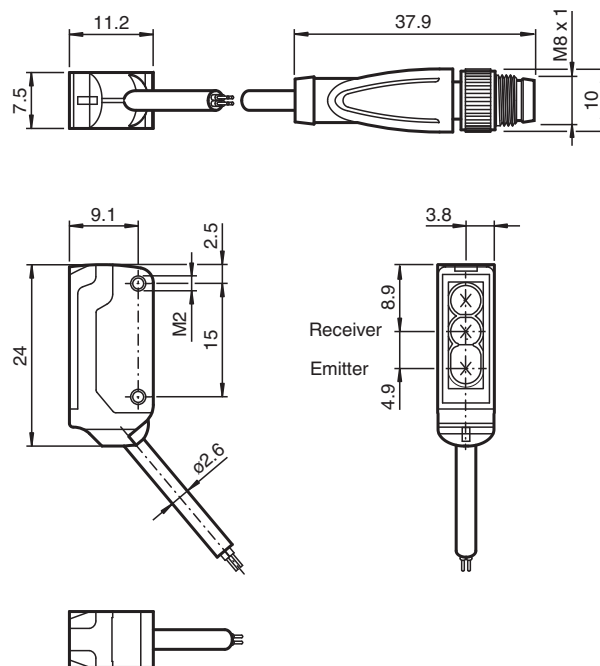

### Technical Data

#### General specifications

Detection range	7 ... 30 mm
Reference target	standard white, 100 mm x 100 mm
Light source	laser diode
Light type	modulated visible red light , 680 nm

Release date: 2023-03-28 Date of issue: 2023-03-28 Filename: 70141886\_eng.pdf

## Technical Data

<b>Laser nominal ratings</b>		
Note		LASER LIGHT , DO NOT STARE INTO BEAM
Laser class		1
Wave length		680 nm
Beam divergence		> 5 mrad
Pulse length		approx. 3 $\mu$ s
Repetition rate		approx. 16.6 kHz
max. pulse energy		9.5 nJ
Black-white difference (6 %/90 %)		< 5 % at 30 mm
Diameter of the light spot		< 1 mm at a distance of 30 mm
Opening angle		approx. 2 °
Optical face		frontal
Ambient light limit		EN 60947-5-2 : 30000 Lux
<b>Functional safety related parameters</b>		
MTTF <sub>d</sub>		800 a
Mission Time (T <sub>M</sub> )		20 a
Diagnostic Coverage (DC)		0 %
<b>Indicators/operating means</b>		
Operation indicator		LED green: Power on flashing: Short circuit/overload indication
Function indicator		LED yellow ON: lights when object is detected
<b>Electrical specifications</b>		
Operating voltage	U <sub>B</sub>	12 ... 24 V
No-load supply current	I <sub>0</sub>	< 10 mA
Protection class		III
<b>Output</b>		
Switching type		NO contact / light-on
Signal output		1 PNP output, short-circuit protected, reverse polarity protected, open collector
Switching voltage		max. 30 V DC
Switching current		max. 50 mA , resistive load
Voltage drop	U <sub>d</sub>	≤ 1.5 V DC
Switching frequency	f	approx. 2 kHz
Response time		250 $\mu$ s
<b>Conformity</b>		
Product standard		EN 60947-5-2
Laser safety		EN 60825-1:2007
<b>Approvals and certificates</b>		
UL approval		E87056 , cULus Recognized, Class 2 Power Source
CCC approval		CCC approval / marking not required for products rated ≤36 V
FDA approval		IEC 60825-1:2007 Complies with 21 CFR 1040.10 and 1040.11 except for deviations pursuant to Laser Notice No. 50, dated June 24, 2007
<b>Ambient conditions</b>		
Ambient temperature		-20 ... 60 °C (-4 ... 140 °F)
Storage temperature		-30 ... 70 °C (-22 ... 158 °F)
<b>Mechanical specifications</b>		
Housing width		7.5 mm
Housing height		24 mm
Housing depth		11.2 mm
Degree of protection		IP67
Connection		200 mm fixed cable with 4-pin, M8x1 connector
<b>Material</b>		
Housing		PC/ABS and TPU
Optical face		PC
Cable		PUR

Release date: 2023-03-28 Date of issue: 2023-03-28 Filename: 70141886\_eng.pdf

## Technical Data

Installation	Fixing screws , 2 x M2 allen head screws included with delivery
Mass	approx. 10 g
Cable length	200 mm

## Connection

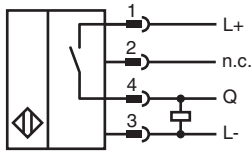

## Connection Assignment



Wire colors in accordance with EN 60947-5-2

1	BN	(brown)
2	WH	(white)
3	BU	(blue)
4	BK	(black)

## Assembly

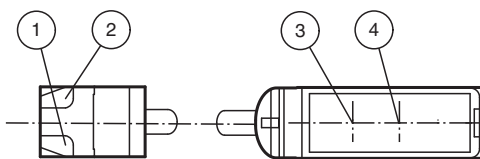

1	Operating display	green
2	Signal display	yellow
3	Emitter	
4	Receiver	

**Characteristic Curve**

**Light spot diameter**

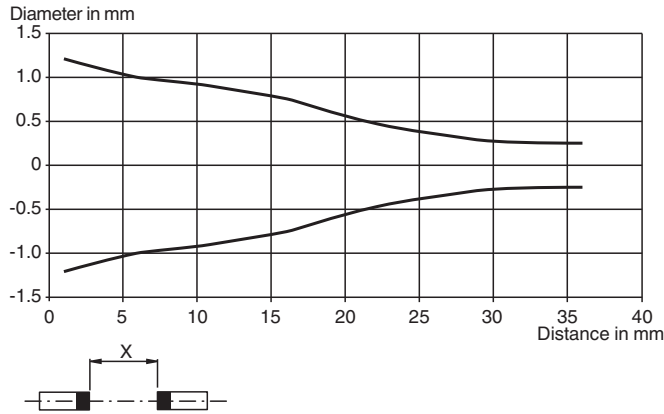

**Detection ranges**

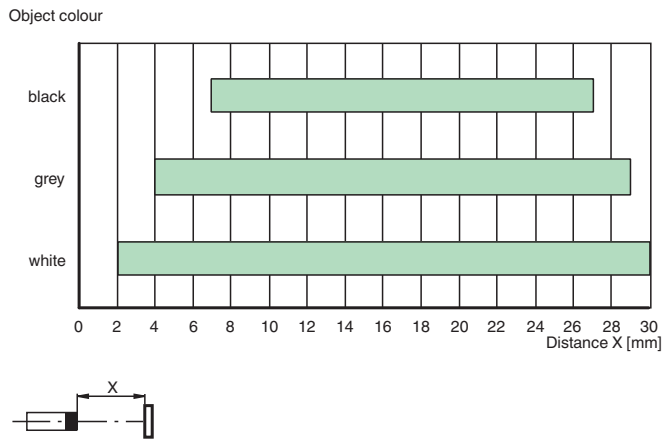

**Safety Information**



Release date: 2023-03-28 Date of issue: 2023-03-28 Filename: 70141886\_eng.pdf

## Safety Information

### Laser Class 1 Information

The irradiation can lead to irritation especially in a dark environment. Do not point at people!





Maintenance and repairs should only be carried out by authorized service personnel!

Attach the device so that the warning is clearly visible and readable.

The warning accompanies the device and should be attached in immediate proximity to the device.

Caution – Use of controls or adjustments or performance of procedures other than those specified herein may result in hazardous radiation exposure.

## Accessories

	<b>V31-WM-2M-PUR</b>	Female cordset single-ended M8 angled A-coded, 4-pin, PUR cable grey
	<b>MH-R2-01</b>	Mounting aid for R2 series, Mounting bracket
	<b>MH-R2-02</b>	Mounting aid for R2 series, Mounting bracket
	<b>MH-R2-03</b>	Mounting aid for R2 series, Mounting bracket
	<b>MH-R2-04</b>	Mounting aid for R2 series, Mounting bracket