



Triangulation sensor (BGS)

OBT50-R2-E2-P-L



- Ultra-small housing design
- DuraBeam Laser Sensors - durable and employable like an LED
- 45° cable outlet for maximum mounting freedom under extremely tight space constraints
- Precision object detection, almost irrespective of the color

Laser triangulation sensor with background suppression, ultra-small design with M2 mounting, 50 mm sensing range, light on, PNP output, 2 m fixed cable



Function

The R2 series nano sensor has been developed for a broad range of applications. It offers excellent durability and is exceptionally easy to install. The housing is compact and, with its 45° cable outlet, can be installed in the smallest spaces. New functional principles and functionality open up a range of new options. The DuraBeam laser sensors are durable and can be used in the same way as a standard sensor.

Dimensions

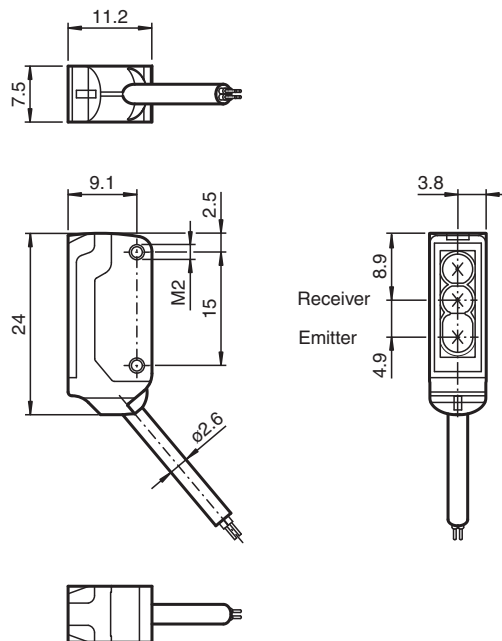

Technical Data

General specifications

Detection range	7 ... 50 mm
Reference target	standard white, 100 mm x 100 mm
Light source	laser diode
Light type	modulated visible red light , 680 nm

Release date: 2023-04-05 Date of issue: 2023-04-05 Filename: 70141906_eng.pdf

Technical Data

Laser nominal ratings		
Note		LASER LIGHT , DO NOT STARE INTO BEAM
Laser class		1
Wave length		680 nm
Beam divergence		> 5 mrad
Pulse length		approx. 3 µs
Repetition rate		approx. 16.6 kHz
max. pulse energy		9.5 nJ
Black-white difference (6 %/90 %)		< 10 % at 50 mm
Diameter of the light spot		approx. 0.8 mm at a distance of 50 mm
Opening angle		approx. 2 °
Optical face		frontal
Ambient light limit		EN 60947-5-2 : 30000 Lux
Functional safety related parameters		
MTTF _d		800 a
Mission Time (T _M)		20 a
Diagnostic Coverage (DC)		0 %
Indicators/operating means		
Operation indicator		LED green, statically lit Power on , short-circuit : LED green flashing (approx. 4 Hz)
Function indicator		LED yellow ON: lights when object is detected
Electrical specifications		
Operating voltage	U _B	12 ... 24 V
No-load supply current	I ₀	< 10 mA
Protection class		III
Output		
Switching type		NO contact / light-on
Signal output		1 PNP output, short-circuit protected, reverse polarity protected, open collector
Switching voltage		max. 30 V DC
Switching current		max. 50 mA , resistive load
Voltage drop	U _d	≤ 1.5 V DC
Switching frequency	f	approx. 2 kHz
Response time		250 µs
Conformity		
Product standard		EN 60947-5-2
Standard conformity		
Standards		EN 60947-5-2:2007 EN 60947-5-2/A1:2012 EN 60825-1:2007 UL 60947-5-2: 2014
Approvals and certificates		
UL approval		E87056 , cULus Recognized, Class 2 Power Source
CCC approval		CCC approval / marking not required for products rated ≤36 V
FDA approval		IEC 60825-1:2007 Complies with 21 CFR 1040.10 and 1040.11 except for deviations pursuant to Laser Notice No. 50, dated June 24, 2007
Ambient conditions		
Ambient temperature		-20 ... 60 °C (-4 ... 140 °F)
Storage temperature		-30 ... 70 °C (-22 ... 158 °F)
Mechanical specifications		
Housing width		7.5 mm
Housing height		24 mm
Housing depth		11.2 mm
Degree of protection		IP67
Connection		2 m fixed cable
Material		
Housing		PC/ABS and TPU
Optical face		PC

Release date: 2023-04-05 Date of issue: 2023-04-05 Filename: 70141906_eng.pdf

Technical Data

Cable	PUR
Installation	Fixing screws , 2 x M2 allen head screws included with delivery
Mass	approx. 20 g
Cable length	2 m

Connection

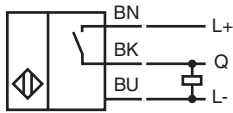

Assembly

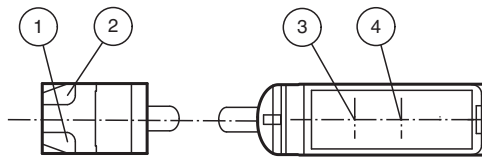

1	Operating display	green
2	Signal display	yellow
3	Emitter	
4	Receiver	

Characteristic Curve

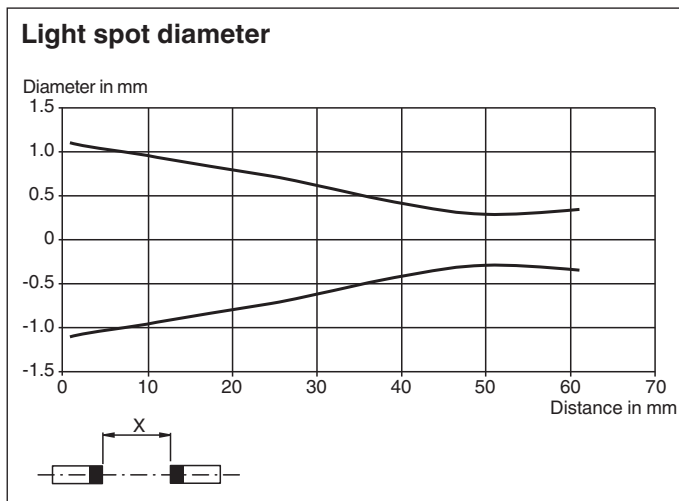

Release date: 2023-04-05 Date of issue: 2023-04-05 Filename: 70141906_eng.pdf

Characteristic Curve

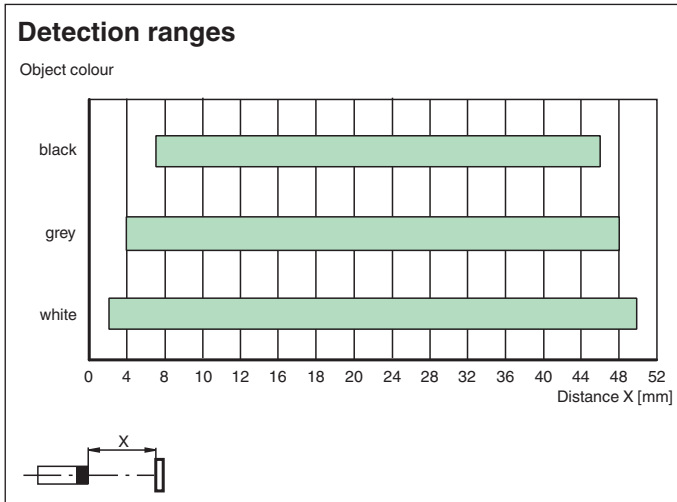

Safety Information



Safety Information

Laser Class 1 Information



The irradiation can lead to irritation especially in a dark environment. Do not point at people!
 Maintenance and repairs should only be carried out by authorized service personnel!
 Attach the device so that the warning is clearly visible and readable.
 The warning accompanies the device and should be attached in immediate proximity to the device.
 Caution – Use of controls or adjustments or performance of procedures other than those specified herein may result in hazardous radiation exposure.

Accessories

	MH-R2-01	Mounting aid for R2 series, Mounting bracket
	MH-R2-02	Mounting aid for R2 series, Mounting bracket

Release date: 2023-04-05 Date of issue: 2023-04-05 Filename: 70141906_eng.pdf

Accessories

	MH-R2-03	Mounting aid for R2 series, Mounting bracket
	MH-R2-04	Mounting aid for R2 series, Mounting bracket