



Triangulation sensor (BGS)

OBT80-R3-E2-P



- 45° cable outlet for maximum mounting freedom under extremely tight space constraints
- Highly visible light spot, even on dark materials
- Precision object detection, almost irrespective of the color
- Extremely long detection range paves the way for new applications

Triangulation sensor with background suppression for standard applications, miniature design, 80 mm sensing range, red light, light on, PNP output, 2 m fixed cable



Function

The nano sensor has been developed for a broad range of applications. It offers excellent durability and is exceptionally easy to install. The housing is compact and, with its 45° cable outlet, can be installed in the smallest spaces. New functional principles and functionality open up a range of new options.

Dimensions

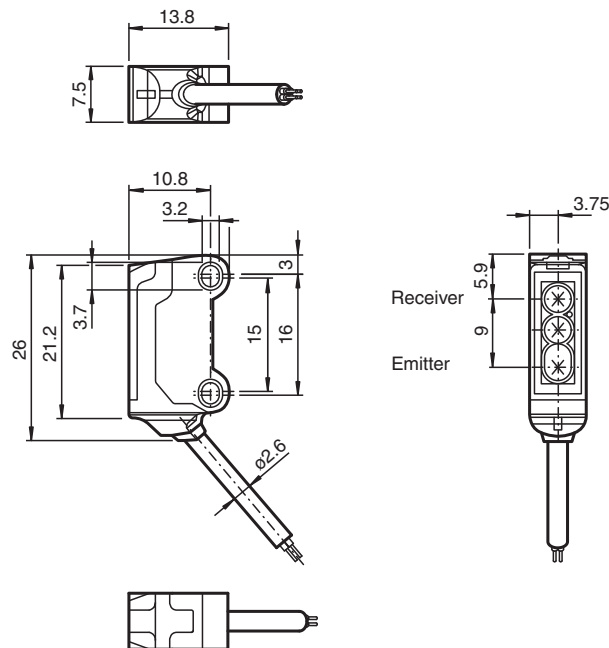

Technical Data

General specifications

Detection range	15 ... 80 mm
Reference target	standard black, 100 mm x 100 mm
Light source	LED
Light type	modulated visible red light , 630 nm

Release date: 2023-10-11 Date of issue: 2023-10-11 Filename: 70141918_eng.pdf

Technical Data

Black-white difference (6 %/90 %)		< 20 %
Angle deviation		approx. 2 °
Diameter of the light spot		approx. 5 mm at a distance of 80 mm
Opening angle		approx. 2 °
Optical face		frontal
Ambient light limit		EN 60947-5-2 : 30000 Lux
Functional safety related parameters		
MTTF _d		800 a
Mission Time (T _M)		20 a
Diagnostic Coverage (DC)		0 %
Indicators/operating means		
Operation indicator		LED green, statically lit Power on , short-circuit : LED green flashing (approx. 4 Hz)
Function indicator		LED yellow ON: lights when object is detected
Electrical specifications		
Operating voltage	U _B	10 ... 30 V DC , class 2
No-load supply current	I ₀	< 10 mA
Protection class		III
Output		
Switching type		NO contact / light-on
Signal output		1 PNP output, short-circuit protected, reverse polarity protected, open collector
Switching voltage		max. 30 V DC
Switching current		max. 50 mA , resistive load
Voltage drop	U _d	≤ 1.5 V DC
Switching frequency	f	approx. 800 Hz
Response time		600 μs
Conformity		
Product standard		EN 60947-5-2
Approvals and certificates		
UL approval		E87056 , cULus Recognized, Class 2 Power Source
CCC approval		CCC approval / marking not required for products rated ≤36 V
Ambient conditions		
Ambient temperature		-25 ... 60 °C (-13 ... 140 °F)
Storage temperature		-30 ... 70 °C (-22 ... 158 °F)
Mechanical specifications		
Housing width		7.5 mm
Housing height		26 mm
Housing depth		13.8 mm
Degree of protection		IP67
Connection		2 m fixed cable
Material		
Housing		PC/ABS and TPU
Optical face		PC
Cable		PUR
Mass		approx. 20 g
Cable length		2 m

Connection Assignment

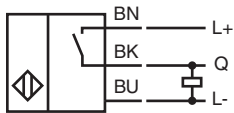

Assembly

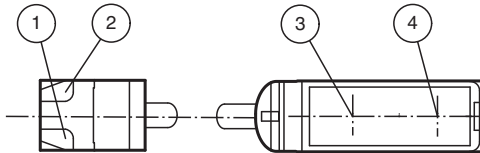



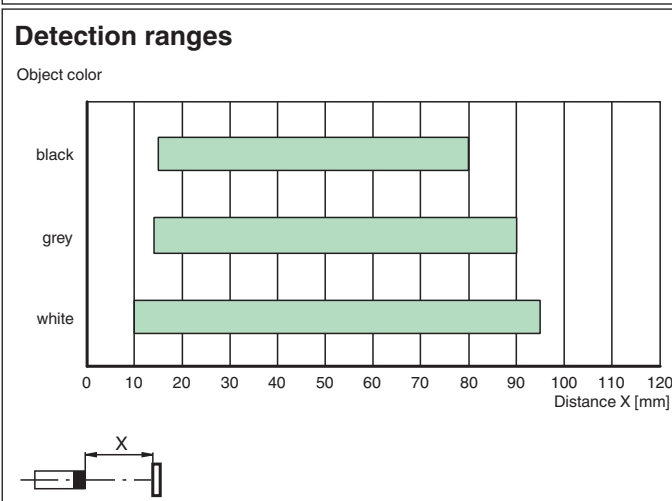
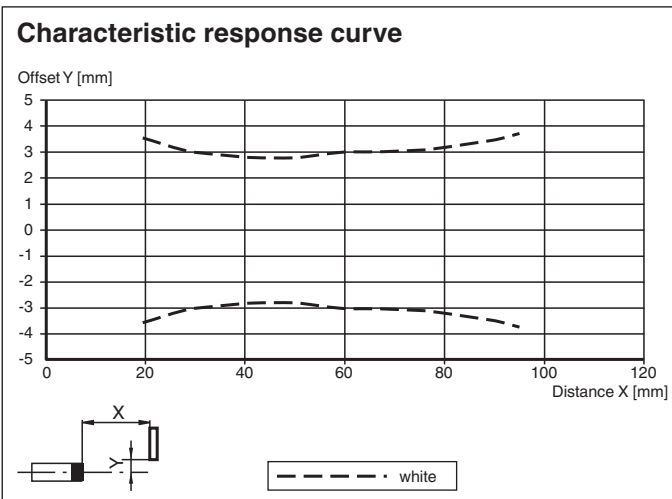

1	Operating display	green
2	Signal display	yellow
3	Emitter	
4	Receiver	

Characteristic Curve



Release date: 2023-10-11 Date of issue: 2023-10-11 Filename: 70141918_eng.pdf

Accessories

	MH-R3-01	Mounting aid for sensors from the R3 series, mounting bracket
	MH-R3-02	Mounting aid for sensors from the R3 series, mounting bracket
	MH-R3-03	Mounting aid for sensors from the R3 series, mounting bracket
	MH-R3-04	Mounting aid for sensors from the R3 series, mounting bracket