



Triangulation sensor (BGS)

OBT80-R2-E2-0,2M-V3-P-L



- High-performance miniature photoelectric sensors
- DuraBeam Laser Sensors - durable and employable like an LED
- 45° cable outlet for maximum mounting freedom under extremely tight space constraints
- Precision object detection, almost irrespective of the color

Laser triangulation sensor with background suppression, ultra-small design with M2 mounting, 80 mm sensing range, light on, PNP output, 200 mm fixed cable with plug M8, 3-pin



Function

The R2 series nano sensor has been developed for a broad range of applications. It offers excellent durability and is exceptionally easy to install. The housing is compact and, with its 45° cable outlet, can be installed in the smallest spaces. New functional principles and functionality open up a range of new options. The DuraBeam laser sensors are durable and can be used in the same way as a standard sensor.

Dimensions

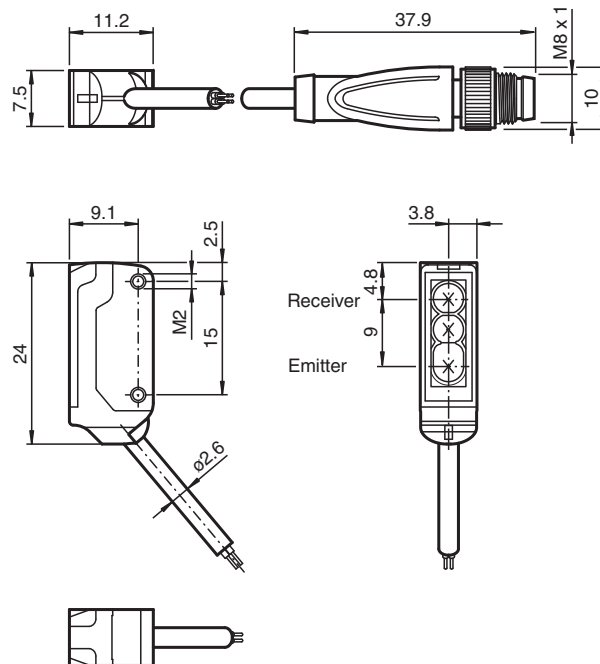

Technical Data

General specifications

| | |
|------------------|--------------------------------------|
| Detection range | 20 ... 80 mm |
| Reference target | standard black, 100 mm x 100 mm |
| Light source | laser diode |
| Light type | modulated visible red light , 680 nm |

Technical Data

| | | |
|---|----------------|--|
| Laser nominal ratings | | |
| Note | | LASER LIGHT , DO NOT STARE INTO BEAM |
| Laser class | | 1 |
| Wave length | | 680 nm |
| Beam divergence | | > 5 mrad |
| Pulse length | | approx. 3 μ s |
| Repetition rate | | approx. 16.6 kHz |
| max. pulse energy | | 9.5 nJ |
| Black-white difference (6 %/90 %) | | < 15 % at 80 mm |
| Diameter of the light spot | | approx. 2 mm at a distance of 80 mm |
| Opening angle | | approx. 2 ° |
| Optical face | | frontal |
| Ambient light limit | | EN 60947-5-2 : 30000 Lux |
| Functional safety related parameters | | |
| MTTF _d | | 800 a |
| Mission Time (T _M) | | 20 a |
| Diagnostic Coverage (DC) | | 0 % |
| Indicators/operating means | | |
| Operation indicator | | LED green, statically lit Power on , short-circuit : LED green flashing (approx. 4 Hz) |
| Function indicator | | LED yellow: lights when object is detected |
| Electrical specifications | | |
| Operating voltage | U _B | 12 ... 24 V |
| No-load supply current | I ₀ | < 10 mA |
| Protection class | | III |
| Output | | |
| Switching type | | NO contact / light-on |
| Signal output | | 1 PNP output, short-circuit protected, reverse polarity protected, open collector |
| Switching voltage | | max. 30 V DC |
| Switching current | | max. 50 mA , resistive load |
| Voltage drop | U _d | ≤ 1.5 V DC |
| Switching frequency | f | approx. 2 kHz |
| Response time | | 250 μ s |
| Conformity | | |
| Product standard | | EN 60947-5-2 |
| Laser safety | | EN 60825-1:2007 |
| Approvals and certificates | | |
| UL approval | | E87056 , cULus Recognized, Class 2 Power Source |
| CCC approval | | CCC approval / marking not required for products rated ≤36 V |
| FDA approval | | IEC 60825-1:2007 Complies with 21 CFR 1040.10 and 1040.11 except for deviations pursuant to Laser Notice No. 50, dated June 24, 2007 |
| Ambient conditions | | |
| Ambient temperature | | -20 ... 60 °C (-4 ... 140 °F) |
| Storage temperature | | -30 ... 70 °C (-22 ... 158 °F) |
| Mechanical specifications | | |
| Housing width | | 7.5 mm |
| Housing height | | 24 mm |
| Housing depth | | 11.2 mm |
| Degree of protection | | IP67 |
| Connection | | 200 mm fixed cable with 3-pin, M8 x 1 connector |
| Material | | |
| Housing | | PC/ABS and TPU |
| Optical face | | PC |
| Cable | | PUR |

Technical Data

| | |
|--------------|---|
| Installation | Fixing screws , 2 x M2 allen head screws included with delivery |
| Mass | approx. 10 g |
| Cable length | 200 mm |

Connection

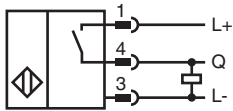

Connection Assignment



Wire colors in accordance with EN 60947-5-2

| | | |
|---|----|---------|
| 1 | BN | (brown) |
| 3 | BU | (blue) |
| 4 | BK | (black) |

Assembly

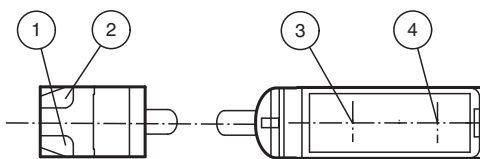

| | | |
|---|-------------------|--------|
| 1 | Operating display | green |
| 2 | Signal display | yellow |
| 3 | Emitter | |
| 4 | Receiver | |

Characteristic Curve

Light spot diameter

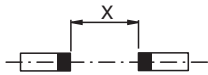
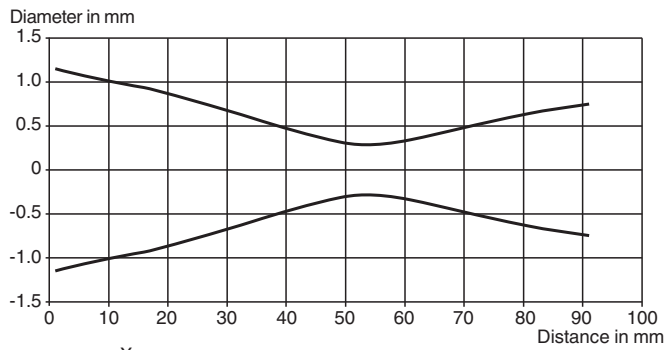

Detection ranges

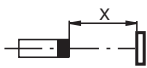
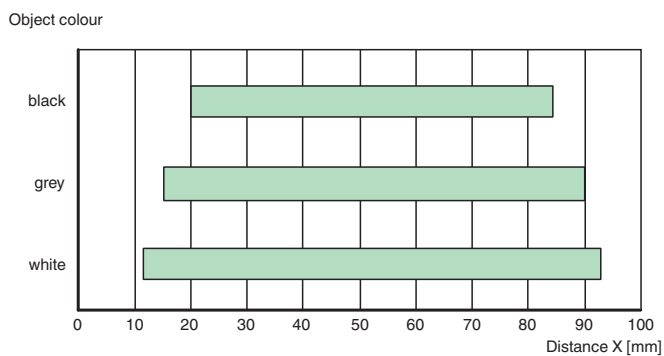

Safety Information



Release date: 2023-04-05 Date of issue: 2023-04-05 Filename: 70141933_eng.pdf

Safety Information

Laser Class 1 Information

The irradiation can lead to irritation especially in a dark environment. Do not point at people!





Maintenance and repairs should only be carried out by authorized service personnel!

Attach the device so that the warning is clearly visible and readable.

The warning accompanies the device and should be attached in immediate proximity to the device.

Caution – Use of controls or adjustments or performance of procedures other than those specified herein may result in hazardous radiation exposure.

Accessories

| | | |
|---|---------------------|--|
|  | V3-WM-2M-PUR | Female cordset single-ended M8 angled A-coded, 3-pin, PUR cable grey |
|  | MH-R2-01 | Mounting aid for R2 series, Mounting bracket |
|  | MH-R2-02 | Mounting aid for R2 series, Mounting bracket |
|  | MH-R2-03 | Mounting aid for R2 series, Mounting bracket |
|  | MH-R2-04 | Mounting aid for R2 series, Mounting bracket |