

Thru-beam sensor

GD18/GV18/25/102/115b-0,4M



- Efficient Line in a short M18 plastic housing for standard applications
- Very high detection range
- 4 LEDs indicator for 360° visibility
- Version with front optical face
- DC voltage version

Thru-beam sensor, M18 threaded housing design, plastic housing, front optical face, 20 m detection range, red light, light on, DC version, NPN output, fixed cable with M12 plug



Function

The GLV/GLK18 series sensors help improve the efficiency of machines and systems. The design of the M18 plastic housing, the connection technology, and sensor properties are highly standardized. Concentrating on the key sensor requirements has produced a robust and reliable product series for DC and AC/DC voltage systems without any over-engineering. The mounting set included in the scope of delivery and the optimized potentiometer design ensure fast assembly and easy configuration.

Application

Packaging industry:

- Presence checks, track loading, completeness checks, stack height control

Material handling:

- Presence checks, target sensor, profile checks, trigger sensor

Automatic doors, gates and access systems, elevator:

- Secure detection for automatic door and gate systems
- Monitoring function in turnstiles
- Closing edge monitoring in elevators

Dimensions

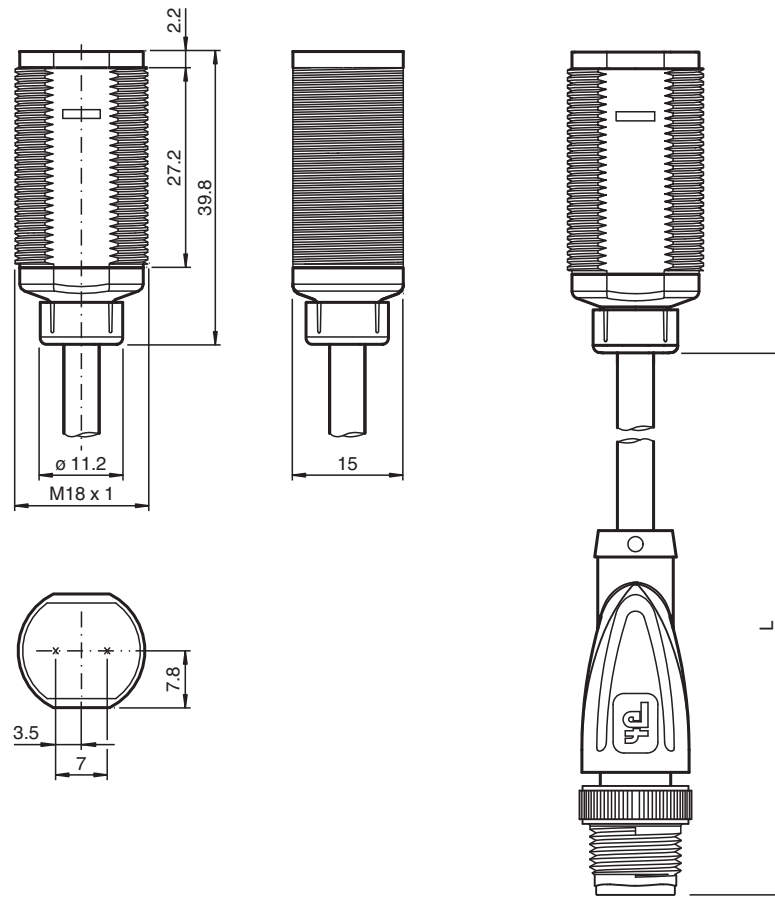

Technical Data

System components		
Emitter		GD18/115b-0,4M
Receiver		GV18/25/102/115b-0,4M
General specifications		
Effective detection range		0 ... 20 m
Threshold detection range		25 m
Light source		LED
Light type		modulated visible red light , 640 nm
Diameter of the light spot		approx. 1300 mm at 25 m
Opening angle		approx. 3 °
Optical face		frontal
Ambient light limit		30000 Lux
Functional safety related parameters		
MTTF _d		630 a
Mission Time (T _M)		20 a
Diagnostic Coverage (DC)		0 %
Indicators/operating means		
Operation indicator		LED green, statically lit Power on
Function indicator		Receiver: LED yellow, lights up when light beam is free, flashes when falling short of the operating reserve ; OFF when light beam is interrupted
Electrical specifications		
Operating voltage	U _B	10 ... 30 V DC

Technical Data

No-load supply current	I_0	< 20 mA
Output		
Switching type		light-on
Signal output		1 NPN, short-circuit protected open collector
Switching voltage		max. 30 V DC
Switching current		max. 100 mA
Voltage drop	U_d	≤ 1.5 V DC
Switching frequency	f	500 Hz
Response time		≤ 1 ms
Conformity		
Product standard		EN 60947-5-2
Approvals and certificates		
Protection class		II, Rated insulation voltage ≤ 50 V AC with pollution degree 1-2 according to IEC 60664-1
UL approval		cULus Listed, Class 2 Power Source, Type 1 enclosure
CCC approval		CCC approval / marking not required for products rated ≤36 V
Ambient conditions		
Ambient temperature		-25 ... 60 °C (-13 ... 140 °F)
Storage temperature		-40 ... 70 °C (-40 ... 158 °F)
Mechanical specifications		
Degree of protection		IP67
Connection		fixed cable 400 mm with M12 x 1 male connector , 4-pin
Material		
Housing		PC
Optical face		PMMA
Cable		
Length	L	400 mm
Mass		approx. 70 g per device

Connection

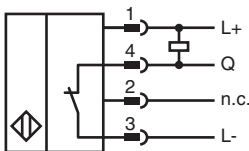
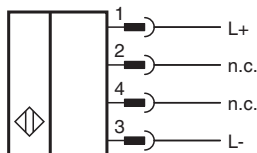

Connection Assignment

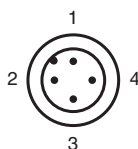

Connection Assignment

Wire colors in accordance with EN 60947-5-2

1	BN	(brown)
2	WH	(white)
3	BU	(blue)
4	BK	(black)

Assembly

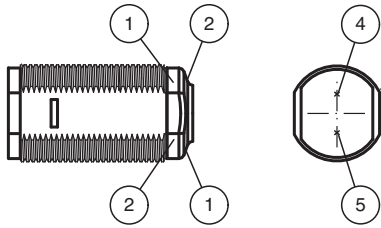

1	Operating display	green
2	Signal display	yellow
4	Emitter	
5	Receiver	



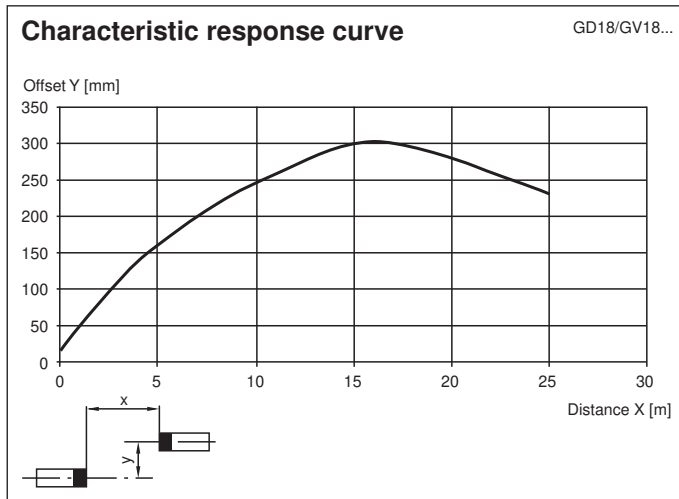

Characteristic Curve

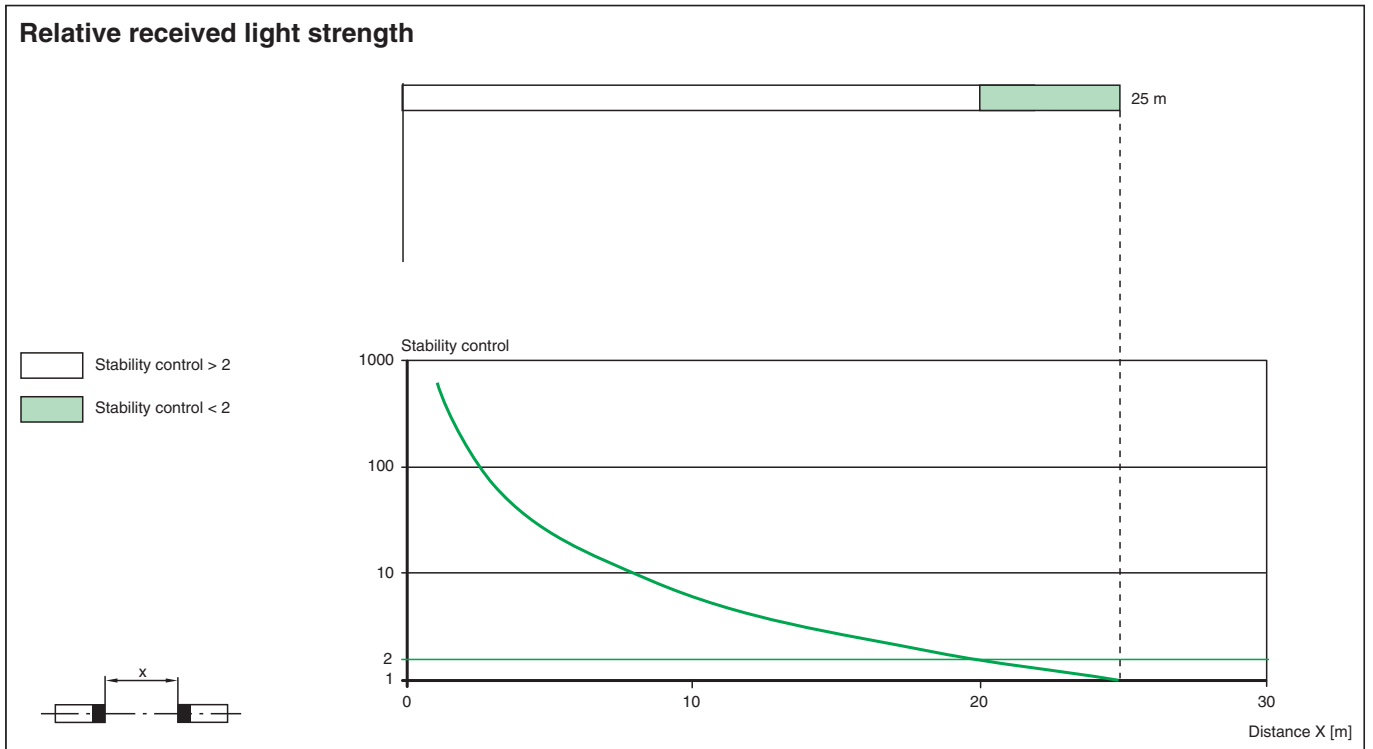

Characteristic Curve



Accessories

	CPZ18B03	Mounting Bracket with swivel nut
	BF 18	Mounting flange, 18 mm
	BF 18-F	Plastic mounting adapter, 18 mm
	BF 5-30	Universal mounting bracket for cylindrical sensors with a diameter of 5 ... 30 mm