

FO Splice Box in Stainless Steel with Return Flange

SR.TFO.26.26.16.B.0-S0007

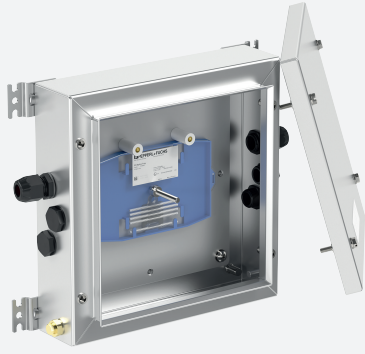

- Safe protection of fiber optic cable splices in hazardous areas
- Installation in Zone 1, Zone 2, Zone 21 and Zone 22
- Ex op pr and Ex tb certified
- Stainless Steel AISI 316L
- 7 splice trays, 12 fusion-type splices per tray



Dimensions

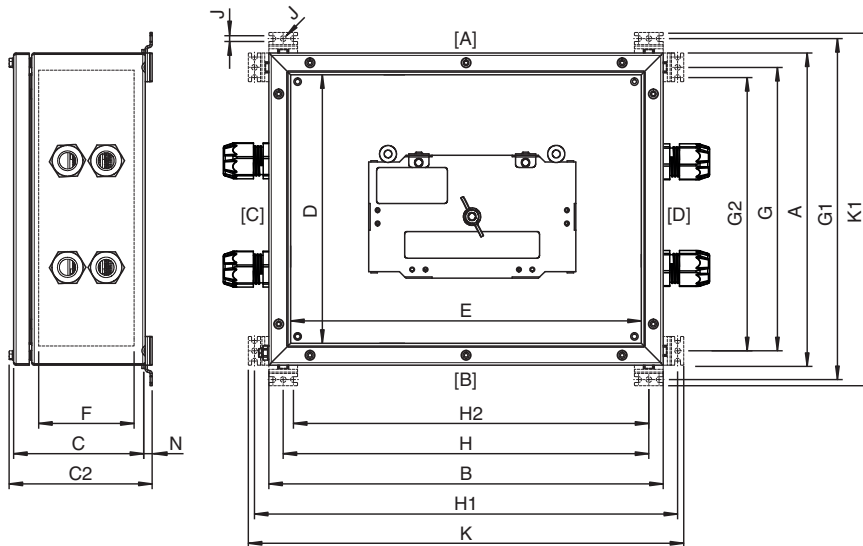

Dimension values see data table.
Image and drawing are generic for this device type and may deviate from the specific variant.

Technical Data

Mechanical specifications

Enclosure cover	fully detachable
Cover fixing	stainless steel A4 (V4A) hexagonal head screws
Screws	M6
Number	4
Tightening torque	3 Nm - 3.5 Nm
Cover seal	silicone
Degree of protection	IP66

Release date: 2023-05-09 Date of issue: 2023-05-09 Filename: 70143981_eng.pdf

Technical Data

Cable entry	thru-holes direct through body
Gland plate on face(s)	
Cable entry face C	
M20 quantity	8
M20 series	7 Cable Glands, Plastic 1 Stopping Plugs, Plastic
M20 type	7 CG.PEDS1.M20.* 1 SP.PE.M20.*
M20 clamping range	6 ... 12 mm
Cable entry face D	
M20 quantity	8
M20 series	7 Cable Glands, Plastic 1 Stopping Plugs, Plastic
M20 type	2 CG.PEDS1.M20.* 1 SP.PE.M20.*
M20 clamping range	6 ... 12 mm
Material	
Enclosure	1.5 mm AISI 316L, (1.4404) stainless steel
Finish	brushed
Mass	approx. 6.2 kg
Dimensions	
External dimension (A)	260 mm
External dimension (B)	260 mm
External dimension (C)	160 mm
External dimension with screws (C2)	174 mm
Internal dimension (D)	206 mm
Internal dimension (E)	206 mm
Internal dimension (F)	124.5 mm
Mounting holes distance (G)	225 mm
Mounting holes distance (G1)	295 mm
Mounting holes distance (G2)	212.5 mm
Mounting holes distance (H)	225 mm
Mounting holes distance (H1)	295 mm
Mounting holes distance (H2)	212.5 mm
Mounting holes diameter (J)	7 mm
Thickness of mounting brackets (N)	8.5 mm
Maximum external dimension (K)	310 mm
Maximum external dimension (K1)	310 mm
Mounting	4 Mounting bracket for wall mounting included in the scope of delivery
Grounding	M6 internal/external brass nickel-plated grounding bolt M6 internal stainless steel grounding bolt welded to lid M6 internal stainless steel grounding bolt welded to enclosure body
Fiber optic splice tray	
Number	7
Dimensions	142 mm x 92 mm x 8 mm
Quantity of splice connections per tray	12
Type of splices	fusion with 60 mm heatshrink protectors
Fiber optic splicing protection holders per tray	2 for heatshrink splice protectors 60 mm, 6 splices each
Fiber optic cables min. bending radius	35 mm
Fiber optic cables frequency range	10 ... 10000 MHz
Standards	DIN 47662 and Telecom standards
Ambient conditions	
Ambient temperature	-40 ... 55 °C (-40 ... 131 °F)
Data for application in connection with hazardous areas	

Release date: 2023-05-09 Date of issue: 2023-05-09 Filename: 70143981_eng.pdf

Technical Data

EU-type examination certificate	CML 20 ATEX 3156X BASEEFA 14 ATEX 0368U
Marking	Ⓜ II 2 GD Ex op pr IIC T* Gb Ex tb IIIC T** °C Db T5/T95 °C @ Ta +55 °C T6/T80 °C @ Ta +40 °C
International approvals	
IECEX approval	IECEX CML 20.0094X IECEX BAS 14.0169U
UKCA approval	CML 21 UKEX 3892X
Further approvals	further on request
Conformity	
Degree of protection	EN60529
CE marking	0102
UKCA marking	2503
General information	
Supplementary information	EC-Type Examination Certificate, Statement of Conformity, Declaration of Conformity, Attestation of Conformity and instructions have to be observed where applicable. For information see www.pepperl-fuchs.com .