



Flexible metal conduit

MEC-VIM8-V4A-4.5

- Protection against contamination and damage
- Stainless steel version

Flexible metal conduit 4.5 m for VIM8 vibration sensors



Dimensions

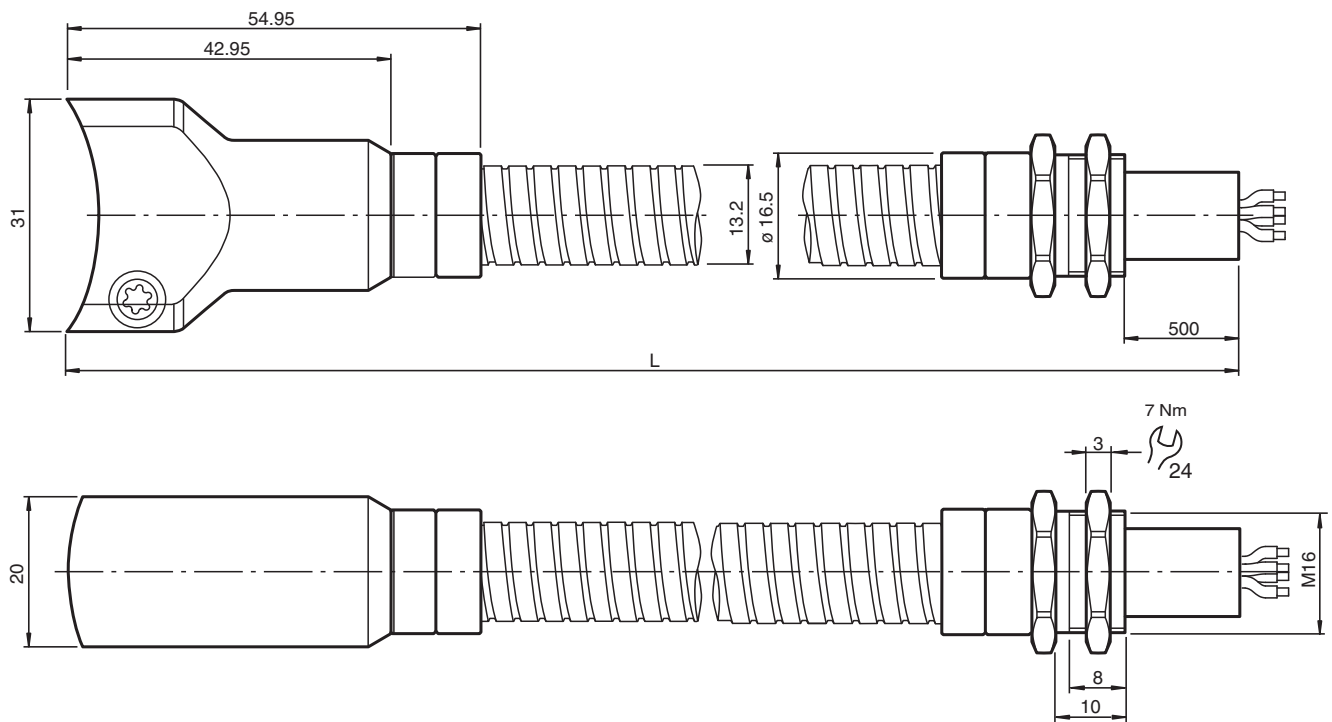

Technical Data

General specifications

Suitable components VIM8* vibration sensors

Ambient conditions

Ambient temperature -40 ... 125 °C (-40 ... 257 °F)

Mechanical specifications

Cable gland

Thread type	metric
Thread size	M16 x 1.5
Height	20 mm
Width	31 mm

Technical Data

Length	L	4.5 m
Material		
Cable gland		Stainless steel 1.4404 / AISI 316L
Flexible metal conduit		Stainless steel 1.4404 / AISI 316L
Fastener		Stainless steel 1.4401 / AISI 316
Mass		800 g