



Triangulation sensor (BGS)

OBT30-R3F-E0-0,2M-V31



- Very flat design for direct mounting without mounting bracket
- Precision object detection, almost irrespective of the color
- Small parts detection from 0.1 mm
- Highly visible light spot, even on dark materials
- High degree of immunity to extraneous light

Triangulation sensor with background suppression for standard applications, flat design, M3 mounting, 30 mm sensing range, red light, light on, NPN output, with 0.2 m fixed cable and M8 plug, 4-pin



Dimensions

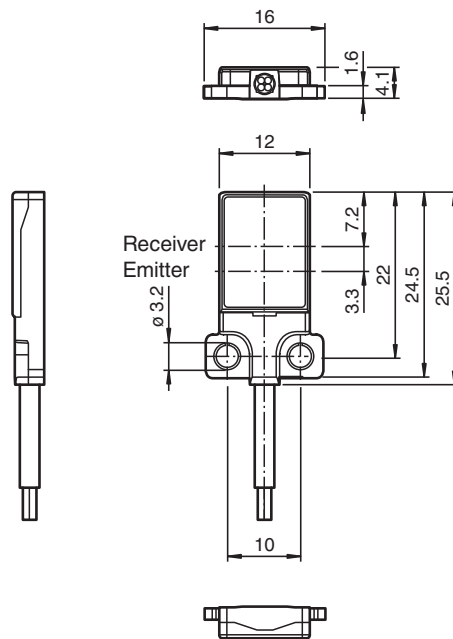

Technical Data

General specifications

Detection range	1 ... 30 mm
Reference target	standard white, 100 mm x 100 mm
Light source	LED
Light type	modulated visible red light , 630 nm
LED risk group labelling	exempt group
Black-white difference (6 %/90 %)	< 20 % at 30 mm
Angle deviation	approx. 2 °
Object size	typ. starts from 0.1 mm @ 16 mm

Technical Data

Diameter of the light spot	approx. 5.5 mm at a distance of 30 mm	
Opening angle	approx. 5 °	
Optical face	frontal	
Ambient light limit	EN 60947-5-2 : 25000 Lux	
Functional safety related parameters		
MTTF _d	800 a	
Mission Time (T _M)	20 a	
Diagnostic Coverage (DC)	0 %	
Indicators/operating means		
Operation indicator	LED green, statically lit Power on , short-circuit : LED green flashing (approx. 4 Hz)	
Function indicator	LED yellow ON: lights when object is detected	
Electrical specifications		
Operating voltage	U _B	10 ... 30 V DC
No-load supply current	I ₀	< 15 mA
Protection class	III	
Output		
Switching type	NO contact / light-on	
Signal output	1 NPN output, short-circuit protected, reverse polarity protected, open collector	
Switching voltage	max. 30 V DC	
Switching current	max. 50 mA , resistive load	
Voltage drop	U _d	≤ 1.5 V DC
Switching frequency	f	approx. 1 kHz
Response time	500 μs	
Conformity		
Product standard	EN 60947-5-2	
Approvals and certificates		
UL approval	E87056 , cULus Recognized, Class 2 Power Source	
CCC approval	CCC approval / marking not required for products rated ≤36 V	
Ambient conditions		
Ambient temperature	-20 ... 60 °C (-4 ... 140 °F)	
Storage temperature	-20 ... 70 °C (-4 ... 158 °F)	
Mechanical specifications		
Housing width	16 mm	
Housing height	25.5 mm	
Housing depth	4.1 mm	
Degree of protection	IP67	
Connection	200 mm fixed cable with 4-pin, M8x1 connector	
Material		
Housing	PC (Polycarbonate) and Stainless steel	
Optical face	PMMA	
Cable	PUR	
Mass	approx. 10 g	
Tightening torque, fastening screws	1 Nm	
Cable length	200 mm	

Connection

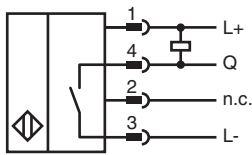

Connection Assignment



Wire colors in accordance with EN 60947-5-2

1	BN	(brown)
2	WH	(white)
3	BU	(blue)
4	BK	(black)

Characteristic Curve

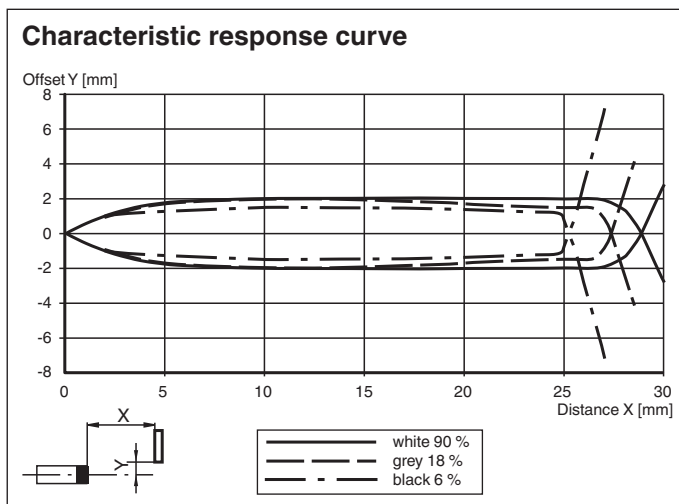

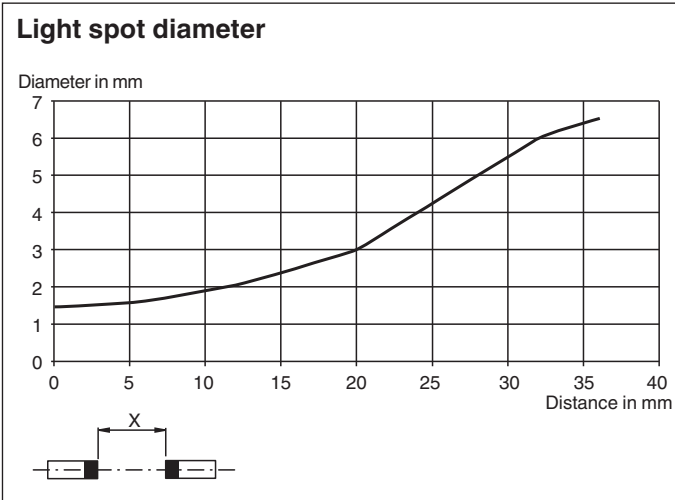
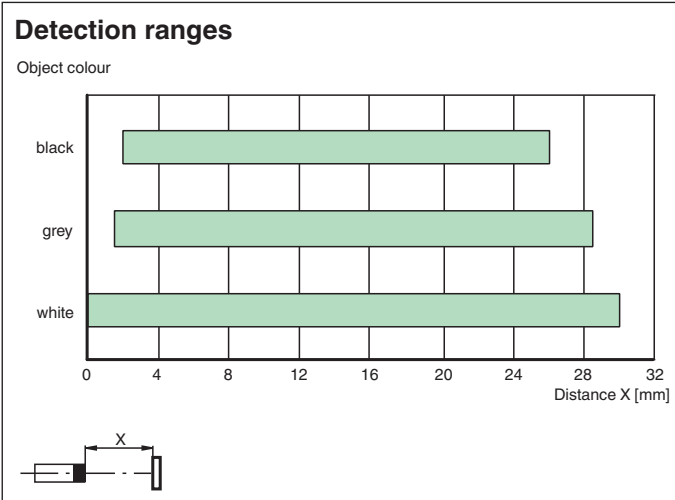

Release date: 2023-03-28 Date of issue: 2023-03-28 Filename: 70146843_eng.pdf

Characteristic Curve



Accessories

	V31-GM-2M-PUR	Female cordset single-ended M8 straight A-coded, 4-pin, PUR cable grey
	V31-WM-2M-PUR	Female cordset single-ended M8 angled A-coded, 4-pin, PUR cable grey

Release date: 2023-03-28 Date of issue: 2023-03-28 Filename: 70146843_eng.pdf