

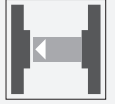

## Thru-beam sensor (pair)

### OBE35M-R202-SK6



- Version for universal voltages
- Medium design with versatile mounting options
- Degree of protection IP67
- Mounting on full metal sockets
- Very bright, highly visible light spot
- Highly visible LEDs for Power ON and switching state
- Easy to use
- Image is generic for this device type and may deviate from the specific variant



## Function

The optical sensors of this series for applications in standard automation have a modern housing design. The sensors are characterized by the many mounting options, easy handling and highly visible LED status indicators. The integrated full metal bushings ensure long-term secure and dimensionally stable mounting.

Due to the integrated all-voltage power supply, the sensors can be operated in the range of 24 ... 240 V AC/DC.

## Dimensions

Drawing is generic for this device type and may deviate from the specific variant.  
For the number of cores refer to connection diagram.

Dimensions

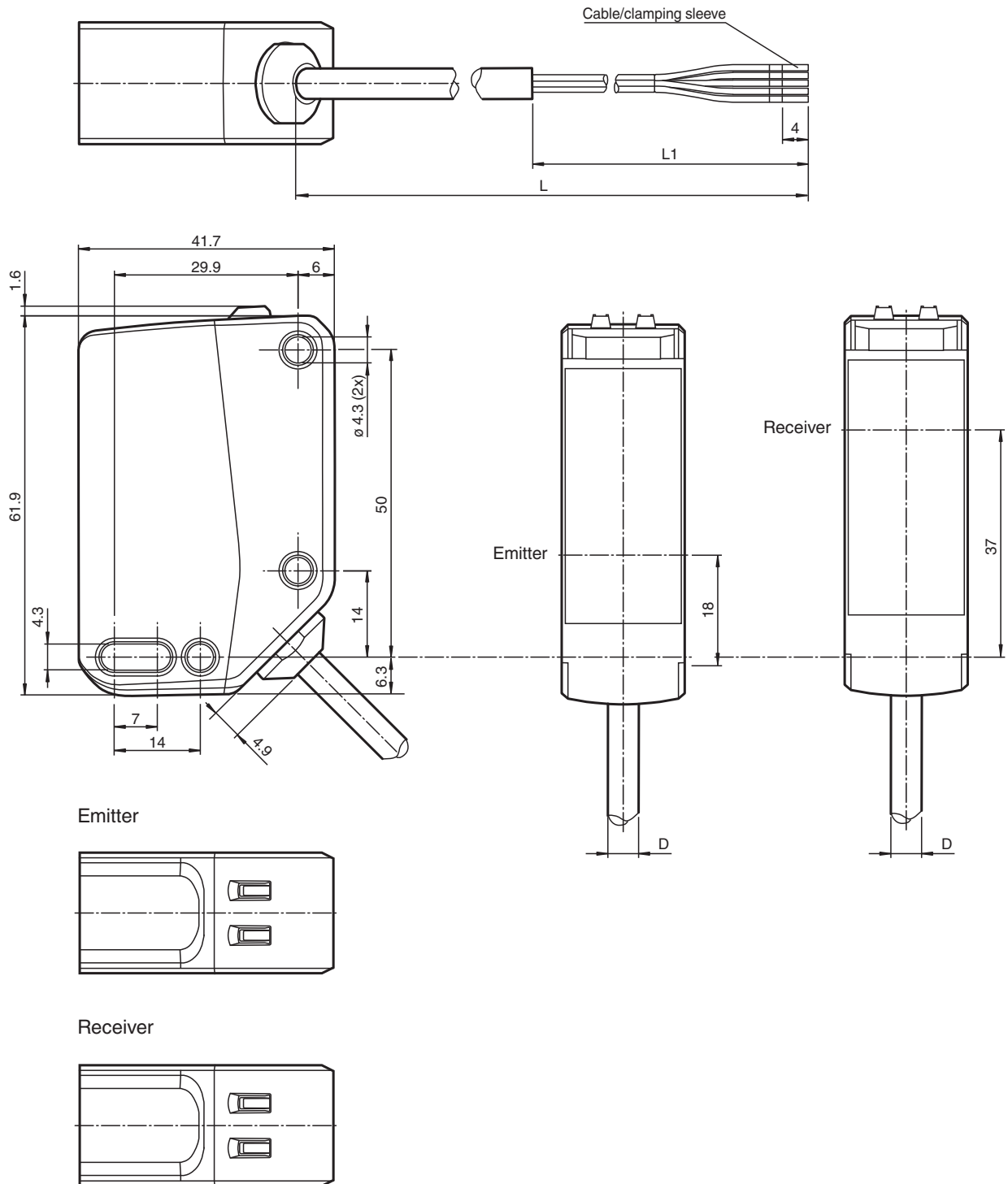

Technical Data

<b>System components</b>	
Emitter	OBE35M-R202-SK
Receiver	OBE35M-R202-K6
<b>General specifications</b>	
Effective detection range	0 ... 35 m
Threshold detection range	47 m
Light source	LED
Light type	modulated visible red light

Release date: 2025-02-18 Date of issue: 2025-02-18 Filename: 70148121\_eng.pdf

## Technical Data

LED risk group labelling		exempt group
Transmitter frequency		F1 = 8.2 kHz
Diameter of the light spot		approx. 1200 mm at a distance of 35 m
Opening angle		2 °
Ambient light limit		EN 60947-5-2 : 40000 Lux
<b>Functional safety related parameters</b>		
MTTF <sub>d</sub>		422 a
Mission Time (T <sub>M</sub> )		20 a
Diagnostic Coverage (DC)		0 %
<b>Indicators/operating means</b>		
Operation indicator		LED green: power on
Function indicator		Yellow LED: Permanently lit - light path clear Permanently off - object detected Flashing (4 Hz) - insufficient operating reserve Flashing (8 Hz) - fault detected, the outputs maintain the status
Control elements		none
<b>Electrical specifications</b>		
Operating voltage	U <sub>B</sub>	24 ... 240 V DC (-30 °C ≤ T <sub>amb</sub> ≤ 60 °C) 24 ... 240 V AC (10 °C ≤ T <sub>amb</sub> ≤ 60 °C) 30 ... 240 V AC (-30 °C ≤ T <sub>amb</sub> ≤ 60 °C)
No-load supply current	I <sub>0</sub>	Emitter: ≤ 15 mA Receiver: ≤ 30 mA at 24 V Operating voltage
Protection class		II
Rated insulation voltage	U <sub>i</sub>	250 V
Rated impulse withstand voltage	U <sub>imp</sub>	2500 V
Power consumption	P <sub>0</sub>	Emitter: ≤ 0.35 VA Receiver: ≤ 0.75 VA
Fuse		Safety fuse ≤ 2 A (slow-blow) according to IEC 60127-2 Sheet 1 Recommendation: after a short circuit, check that the device is functioning correctly.
<b>Output</b>		
Switching type		Q - BK: normally-open / dark-on /Q - GY: normally-closed / light-on C - WH: Common
Signal output		Relay, 1 alternator
Switching voltage		max. 240 V AC/DC
Switching current		max. 2.5 A , see section characteristic curve
Switching power		DC: max. 95 W AC: max. 600 VA
Usage category		DC-12 , DC-13 , AC-12 u. AC-140
Switching frequency	f	25 Hz
Response time		≤ 20 ms
<b>Conformity</b>		
Product standard		EN 60947-5-2 , EN 60947-1
<b>Approvals and certificates</b>		
UL approval		E87056 , cULus Listed
<b>Ambient conditions</b>		
Ambient temperature		-30 ... 60 °C (-22 ... 140 °F) , cable, fixed installation -20 ... 60 °C (-4 ... 140 °F) , movable cable not appropriate for conveyor chains
Storage temperature		-40 ... 70 °C (-40 ... 158 °F)
Pollution degree		3
<b>Mechanical specifications</b>		
Degree of protection		IP67
Connection		2 m fixed cable
Material		
Housing		PC (Polycarbonate)
Optical face		PMMA
Mass		Emitter: approx. 90 g receiver: approx. 120 g

## Technical Data

Dimensions	
Height	61.9 mm
Width	20 mm
Depth	41.7 mm
Cable length	2 m

## Connection

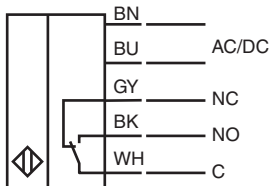
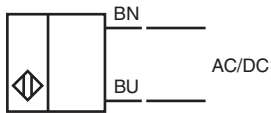

## Indication

### Emitter

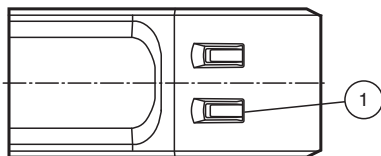

1	Operation indicator	GN
---	---------------------	----

### Receiver

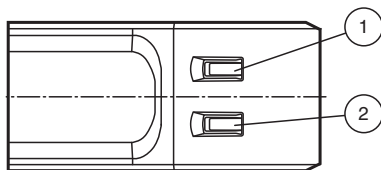

1	Signal indicator	YE
2	Operation indicator	GN

Release date: 2025-02-18 Date of issue: 2025-02-18 Filename: 70148121\_eng.pdf

**Characteristic Curve**

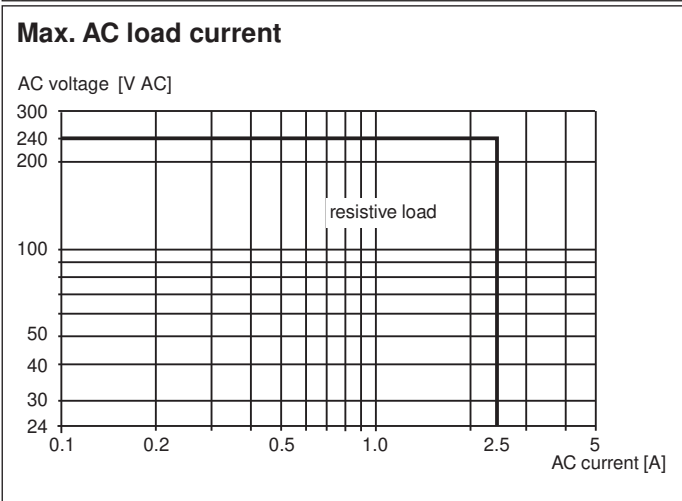
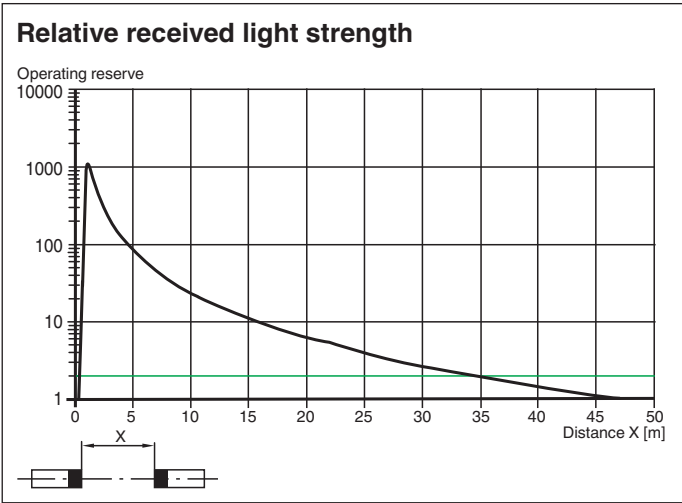
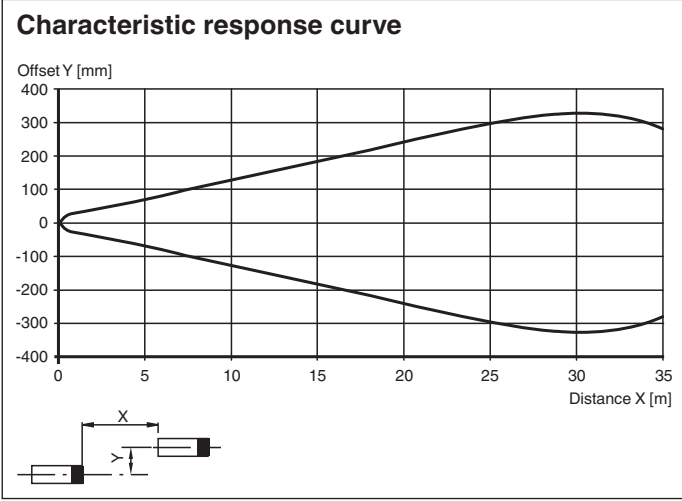

Release date: 2025-02-18 Date of issue: 2025-02-18 Filename: 70148121\_eng.pdf

## Characteristic Curve

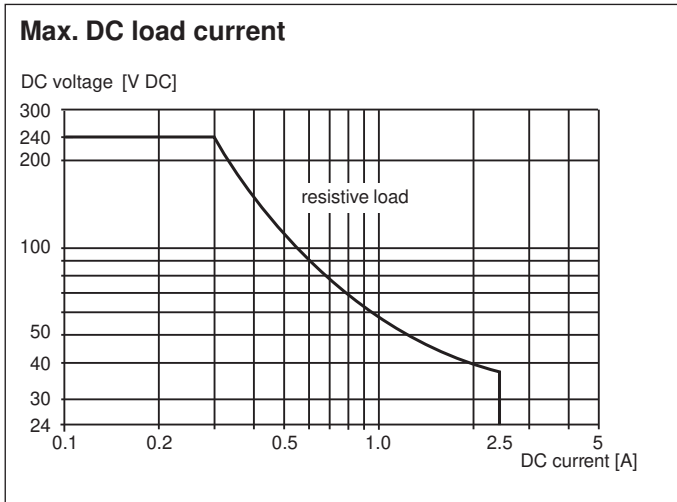

Release date: 2025-02-18 Date of issue: 2025-02-18 Filename: 70148121\_eng.pdf