



Thru-beam sensor (pair)

OBE10M-R3-SE1-0,2M-V31-P-L



- Ultra-small housing design
- DuraBeam Laser Sensors - durable and employable like an LED
- 45° cable outlet for maximum mounting freedom under extremely tight space constraints

Laser thru-beam sensor, ultra-small design with M3 mounting, 10 m detection range, light on, NPN output, 200 mm fixed cable with plug M8, 4-pin



Function

The R3 series nano sensor has been developed for a broad range of applications. It offers excellent durability and is exceptionally easy to install. The housing is compact and, with its 45° cable outlet, can be installed in the smallest spaces. New functional principles and functionality open up a range of new options. The DuraBeam laser sensors are durable and can be used in the same way as a standard sensor.

Dimensions

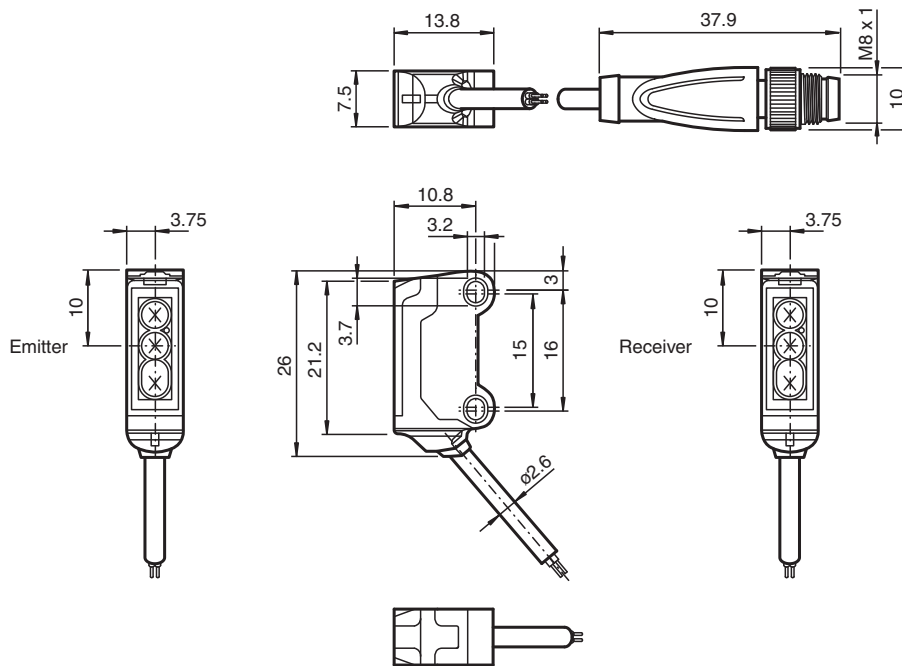

Technical Data

System components	
Emitter	OBE10M-R3-S-0,2M-V31-P-L
Receiver	OBE10M-R3-E1-0,2M-V31-P-L
General specifications	
Effective detection range	0 ... 10 m

Release date: 2023-03-28 Date of issue: 2023-03-28 Filename: 70152775_eng.pdf

Technical Data

Threshold detection range	15 m	
Light source	laser diode	
Light type	modulated visible red light , 680 nm	
Laser nominal ratings		
Note	LASER LIGHT , DO NOT STARE INTO BEAM	
Laser class	1	
Wave length	680 nm	
Beam divergence	> 5 mrad	
Pulse length	approx. 3 μ s	
Repetition rate	approx. 16.6 kHz	
max. pulse energy	9.5 nJ	
Diameter of the light spot	approx. 20 mm at a distance of 10 m	
Opening angle	approx. 0.5 °	
Optical face	frontal	
Ambient light limit	EN 60947-5-2 : 30000 Lux	
Functional safety related parameters		
MTTF _d	806 a	
Mission Time (T _M)	20 a	
Diagnostic Coverage (DC)	0 %	
Indicators/operating means		
Operation indicator	LED green, statically lit Power on , short-circuit : LED green flashing (approx. 4 Hz)	
Function indicator	Receiver: LED yellow, lights up when light beam is free, flashes when falling short of the operating reserve ; OFF when light beam is interrupted	
Electrical specifications		
Operating voltage	U _B	12 ... 24 V
No-load supply current	I ₀	Emitter: \leq 10 mA Receiver: \leq 8 mA
Protection class	III	
Input		
Test input	Test of switching function at 0 V	
Switching threshold	Teach-In input	
Output		
Switching type	NC contact / light on	
Signal output	1 NPN output, short-circuit protected, reverse polarity protected, open collector	
Switching voltage	max. 30 V DC	
Switching current	max. 50 mA , resistive load	
Voltage drop	U _d	\leq 1.5 V DC
Switching frequency	f	approx. 2 kHz
Response time	250 μ s	
Conformity		
Product standard	EN 60947-5-2	
Laser safety	EN 60825-1:2007	
Approvals and certificates		
UL approval	E87056 , cULus Recognized, Class 2 Power Source	
CCC approval	CCC approval / marking not required for products rated \leq 36 V	
FDA approval	IEC 60825-1:2007 Complies with 21 CFR 1040.10 and 1040.11 except for deviations pursuant to Laser Notice No. 50, dated June 24, 2007	
Ambient conditions		
Ambient temperature	-20 ... 60 °C (-4 ... 140 °F)	
Storage temperature	-30 ... 70 °C (-22 ... 158 °F)	
Mechanical specifications		
Housing width	7.5 mm	
Housing height	26 mm	
Housing depth	13.8 mm	

Technical Data

Degree of protection	IP67
Connection	200 mm fixed cable with 4-pin, M8x1 connector
Material	
Housing	PC/ABS and TPU
Optical face	PC
Cable	PUR
Mass	approx. 10 g per sensor
Cable length	200 mm

Connection

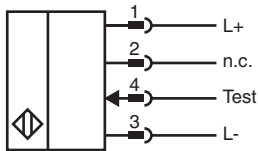
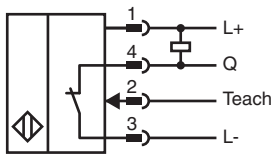

Connection Assignment



Wire colors in accordance with EN 60947-5-2

1	BN	(brown)
2	WH	(white)
3	BU	(blue)
4	BK	(black)

Assembly

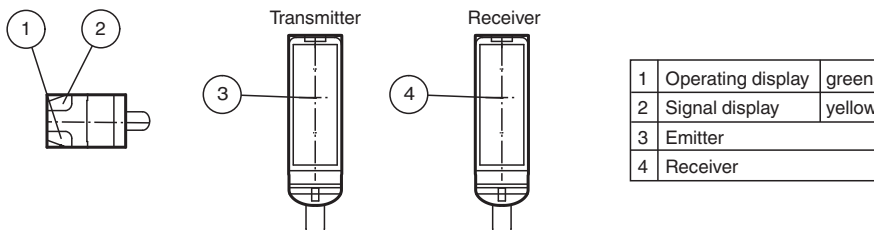

Characteristic Curve

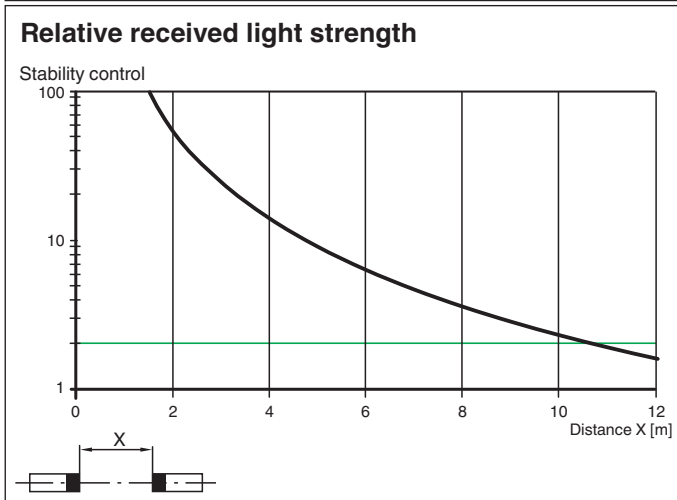
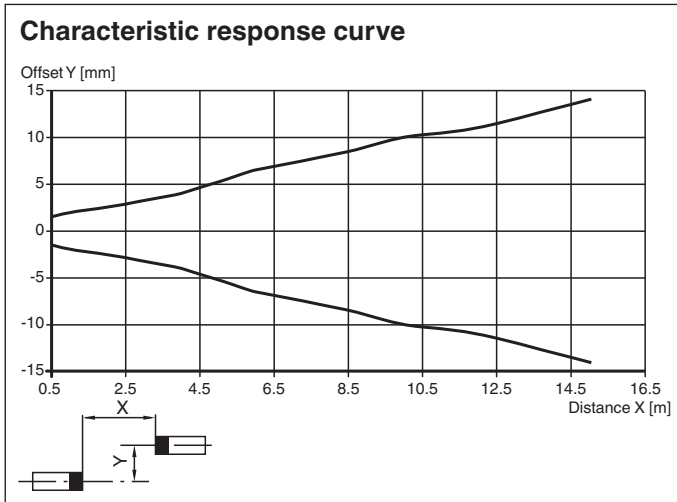

Safety Information

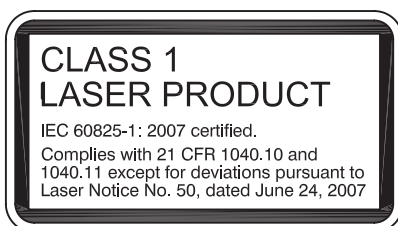

Release date: 2023-03-28 Date of issue: 2023-03-28 Filename: 70152775_eng.pdf

Safety Information

Laser Class 1 Information

The irradiation can lead to irritation especially in a dark environment. Do not point at people!





Maintenance and repairs should only be carried out by authorized service personnel!

Attach the device so that the warning is clearly visible and readable.

The warning accompanies the device and should be attached in immediate proximity to the device.

Caution – Use of controls or adjustments or performance of procedures other than those specified herein may result in hazardous radiation exposure.

Accessories

	V31-WM-2M-PUR	Female cordset single-ended M8 angled A-coded, 4-pin, PUR cable grey
	MH-R3-01	Mounting aid for sensors from the R3 series, mounting bracket
	MH-R3-02	Mounting aid for sensors from the R3 series, mounting bracket
	MH-R3-03	Mounting aid for sensors from the R3 series, mounting bracket
	MH-R3-04	Mounting aid for sensors from the R3 series, mounting bracket

Teach-In

The thru-beam sensor enables the switching points to be taught in for optimum adaptation to specific applications. This eliminates the need for additional components such as apertures.

The sensitivity of the thru-beam sensor can be adjusted using three Teach-in methods:

Position Teach

When using this Teach-in method, the following settings are made on the thru-beam sensor:

- The gain is set to an optimum value
- The signal threshold is set to a minimum

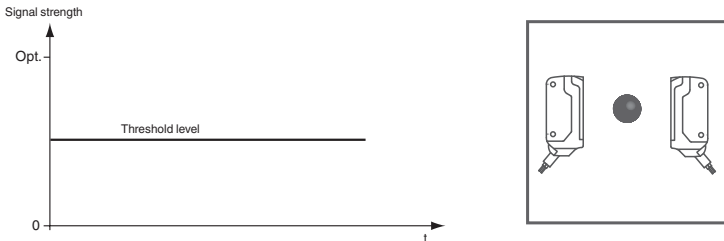

Recommended application:

This method enables minuscule particles in the beam path to be detected, and provides exceptional positioning accuracy. Make sure that there are no objects in the beam path and that the sensor is connected to the power supply.

1. Connect the white cable on the receiver (WH/IN) to the blue cable (BU/0 V) on the receiver.
The green and yellow LED indicators flash simultaneously at 2.5 Hz
2. Disconnect the white cable on the receiver (WH/IN) from the blue cable (BU/0 V) on the receiver.
The green and yellow LED indicators flash alternately at 2.5 Hz
3. The end of the Teach-in process is indicated when the green LED indicator lights up static and yellow LED blinks.

Two-Point Teach-In

When using this Teach-in method, the following settings are made on the thru-beam sensor:

- The gain is set to an optimum value
- The signal threshold is set in the center between the two taught signal values

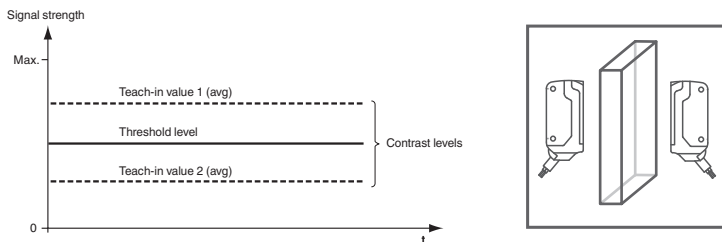

1. Make sure that there are no objects in the beam path and that the sensor is connected to the power supply.
2. Connect the white cable on the receiver (WH/IN) to the blue cable (BU/0 V) on the receiver.
The green and yellow LED indicators flash simultaneously at 2.5 Hz
3. Position the object in the beam path.
4. Disconnect the white cable on the receiver (WH/IN) from the blue cable (BU/0 V) on the receiver.
The green and yellow LED indicators flash alternately at 2.5 Hz
5. The end of the Teach-in process is indicated when the green LED indicator lights up static.

Maximum Teach-In

When using this Teach-in method, the following settings are made on the thru-beam sensor:

- The gain is set to a maximum
- The signal threshold is set to a minimum

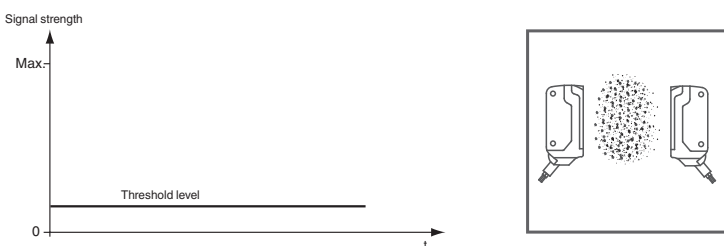

Recommended application:

Enables an object to be detected with a high excess gain. This can be useful if there is severe environmental contamination or to achieve long operating times.

Make sure that there are no objects in the beam path and that the sensor is connected to the power supply.

6. Cover the receiver or transmitter.
7. Connect the white cable on the receiver (WH/IN) to the blue cable (BU/0 V) on the receiver.

Release date: 2023-03-28 Date of issue: 2023-03-28 Filename: 70152775_eng.pdf

Thru-beam sensor (pair)

OBE10M-R3-SE1-0,2M-V31-P-L

The green and yellow LED indicators flash simultaneously at 2.5 Hz

8. Disconnect the white cable on the receiver (WH/IN) from the blue cable (BU/0 V) on the receiver.
The green and yellow LED indicators flash alternately at 2.5 Hz
9. The end of the Teach-in process is indicated when the green LED indicator lights up static.