



Retroreflective area sensor OGR4000-R305-2EP-IO-V1



- Retroreflective area sensor with five light beams in a standard photoelectric sensor enclosure
- Bright, highly visible transmitter beams guarantee convenient alignment of the sensor
- Reliable detection of all surfaces irrespective of the object texture
- Reliable small part detection for very flat objects with an irregular shape
- Constant object detection from 2 mm within the entire detection area

Retroreflective area sensor, red light, max. detection range 4 m, light field height 60 mm, IO-Link interface, 2 push-pull outputs, M12 plug



Function

The retroreflective area sensor contains several emitters and a receiver in a single housing. With a suitable reflector, the device can achieve a range of up to 4 m. Up to a range of 1.5 m, small parts from 2 mm in size can be precisely detected without multiple switching. The device specializes in the reliable detection of flat and irregularly shaped objects. Quick and easy commissioning, as well as additional functions such as suppression of conveyor belts or measurement of object height and data output via IO-Link, round off the range of features offered by the device.

Dimensions

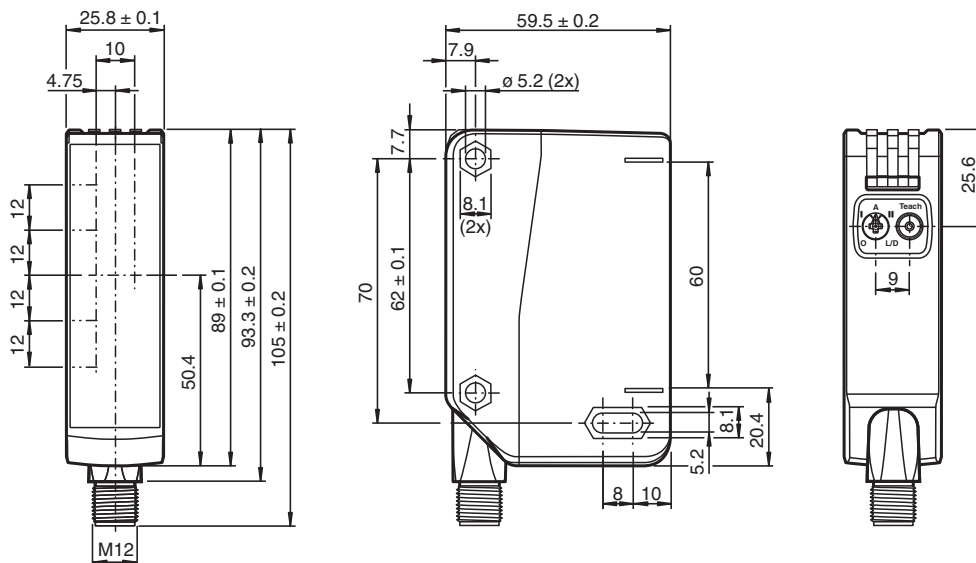

Technical Data

General specifications

Effective detection range	Standard mode: 0 ... 4 m High resolution: 0 ... 2 m
Reflector distance	0.2 ... 4 m H85-2 reflector
Threshold detection range	4 m
Sensing range	see table
Reference target	H85-2 reflector
Light source	LED
Light type	modulated visible red light

Technical Data

LED risk group labelling		exempt group
Field height		60 mm
Field width		12 mm
Object size		Minimum 2 mm, 3 mm, 5 mm, 8 mm, 10 mm; position-independent detection within detection range
Number of beams		5
Opening angle		+/- 2 °
Ambient light limit		EN 60947-5-2
Resolution		see table
Functional safety related parameters		
MTTF _d		674 a
Mission Time (T _M)		20 a
Diagnostic Coverage (DC)		0 %
Indicators/operating means		
Operation indicator		LED green: constantly on - power on flashing (4Hz) - short circuit flashing with short break (1 Hz) - IO-Link mode
Function indicator		Yellow LED: Permanently on: light path clear Permanently off: object detected Flashing (8 Hz) - end of compensation
Control elements		Teach-In key
Control elements		5-step rotary switch for operating modes selection
Electrical specifications		
Operating voltage	U _B	10 ... 30 V DC IO-Link mode: 18 ... 30 V DC
Ripple		max. 10 %
No-load supply current	I ₀	< 35 mA at 24 V supply voltage
Protection class		III
Interface		
Interface type		IO-Link
IO-Link revision		1.1
Device profile		Identification and Diagnosis - I&D Smart Sensor - SSP 2.1
Process data		Input 8 Bit - switching signal 1 Bit - stability alarm 1 Bit - measurement value 6 Bit Output 2 Bit - sensor control function 1 Bit - evaluation control function 1 Bit
Vendor ID		1 (0x0001)
Device ID		0x101001 (1052673)
Transfer rate		COM2 (38.4 kBit/s)
Min. cycle time		2.3 ms
SIO mode support		yes
Compatible master port type		Class A , Class B (use 3-pole adapter or 3-wire cable)
Output		
Switching type		The switching type of the sensor is adjustable. The default setting is: C/Q - Pin4: NPN normally open / dark-on, PNP normally closed / light-on, IO-Link /Q - Pin2: NPN normally closed / light-on, PNP normally open / dark-on
Signal output		2 push-pull (4 in 1) outputs, short-circuit protected, reverse polarity protected, overvoltage protected
Switching voltage		max. 30 V DC
Switching current		max. 100 mA
Voltage drop	U _d	≤ 1.5 V DC
Switching frequency	f	Standard mode: 500 Hz , High resolution: 250 Hz
Response time		Standard mode: 1 ms , High resolution: 2 ms
Conformity		

Technical Data

Communication interface	IEC 61131-9 / IO-Link V1.1.4
Product standard	EN 60947-5-2
Approvals and certificates	
UL approval	E87056 , cULus Listed , class 2 power supply , type rating 1
CCC approval	CCC approval / marking not required for products rated ≤ 36 V
Ambient conditions	
Ambient temperature	-40 ... 60 °C (-40 ... 140 °F) The permissible minimum ambient temperature during teach-in is -30 °C. The permissible temperature change after teach-in is ± 20 K.
Storage temperature	-40 ... 70 °C (-40 ... 158 °F)
Mechanical specifications	
Degree of protection	IP67
Connection	4-pin, M12 x 1 connector, 90° rotatable
Material	
Housing	PC (Polycarbonate)
Optical face	Plastic pane
Mass	94 g
Dimensions	
Height	89 mm
Width	25.8 mm
Depth	59.5 mm

Connection Assignment

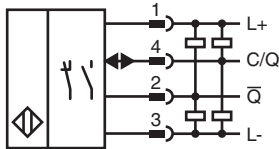

Connection Assignment

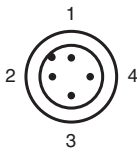

Wire colors in accordance with EN 60947-5-2

1	BN	(brown)
2	WH	(white)
3	BU	(blue)
4	BK	(black)

Assembly

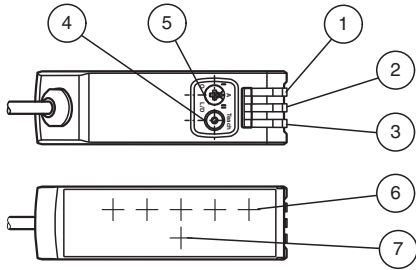

1	Operating indicator light on	GN
2	Signal indicator	YE
3	Operating indicator dark on	GN
4	Teach-in push button	
5	Operating mode selector switch	
6	Emitter	
7	Receiver	

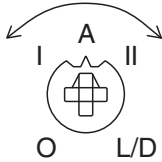

O	Keylock, operating mode, teach-in button is disabled
I	High resolution mode
A	Alignment mode
II	Standard resolution mode
L/D	Light on/dark on

Characteristic Curve

Minimum Detectable Object (MDO)

High Resolution Mode

REF-H85-2

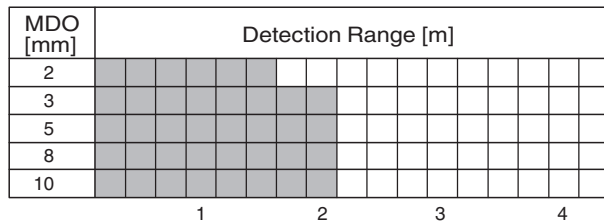

REF-A80

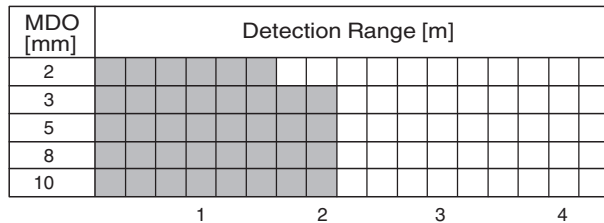

REF-H60-3

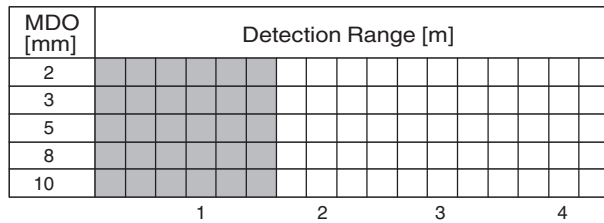

OFR-100/100

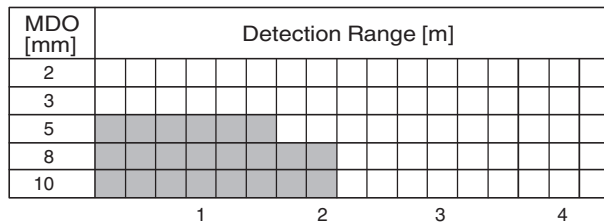

Standard Mode

REF-H85-2

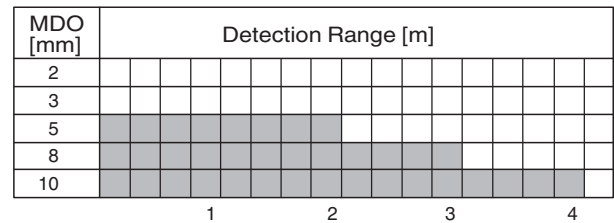

REF-A80

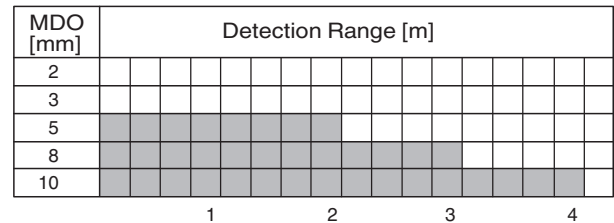

REF-H60-3

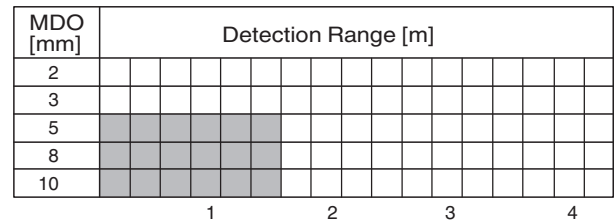

OFR-100/100

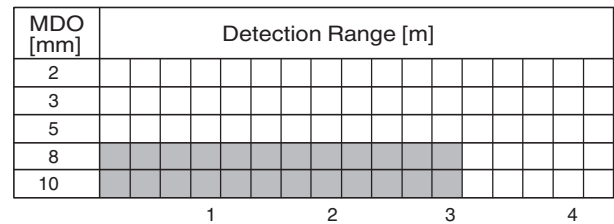

Release date: 2025-06-14 Date of issue: 2025-06-14 Filename: 70154427_eng.pdf

Characteristic Curve

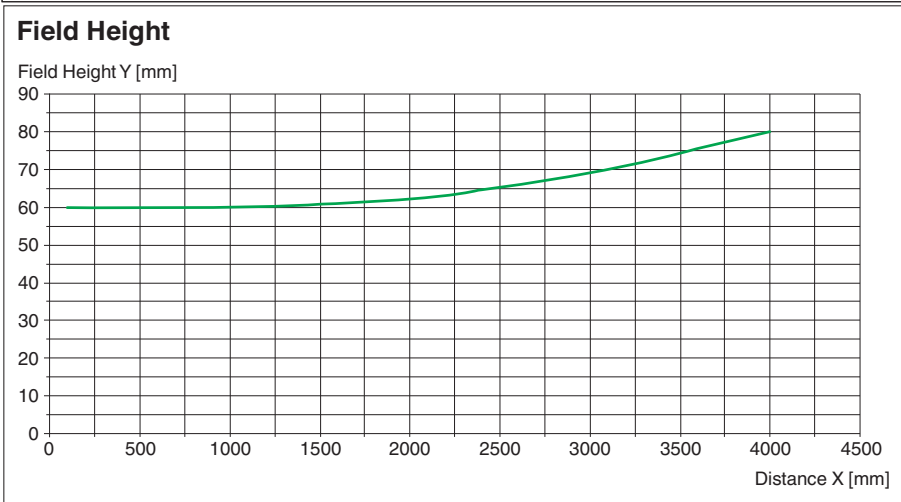
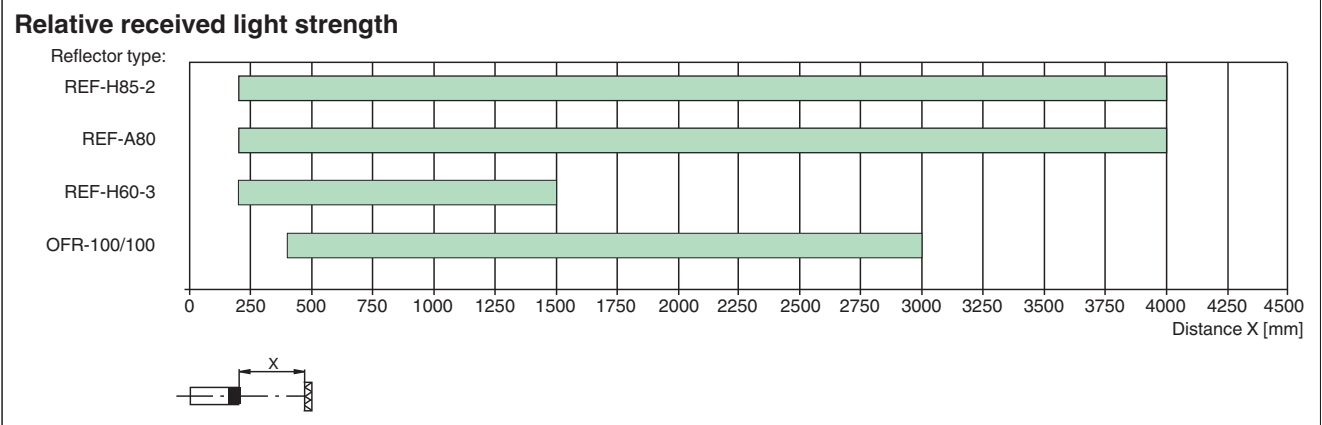

Technical Features

Resolution

Operating mode	High resolution mode	Standard mode
Effective detection range	0 ... 2 m	0 ... 4 m
Resolution	2 mm: 0 ... 1.5 m 3 mm: 0 ... 2 m	5 mm: 0 ... 2 m 8 mm: 0 ... 3 m 10 mm: 0 ... 4 m

Release date: 2025-06-14 Date of issue: 2025-06-14 Filename: 70154427_eng.pdf